

GLOSTAVENT® HELIX DUO ANAESTHESIA SYSTEM INSTRUCTIONS FOR USE MANUAL

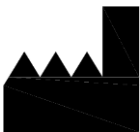

For anaesthesia and ventilation in difficult circumstances



Diamedica (UK) Ltd
Unit 1 Kingdom Fields
Bratton Fleming, Barnstaple, Devon,
EX31 4EN, United Kingdom

Tel: +44 (0)1598 710066
WhatsApp: +44 (0) 7716 503156
Email: support@diamedica.co.uk
Web: www.diamedica.co.uk



Advena Limited
Tower Business Centre, Tower Street
Swatar, BKR 4013, Malta



Revision G 24/11/2025 DCN-0344
Document no: DTF-0001-IFU-GVH2



1 READ THIS SECTION FIRST

1.1 INTENDED USE

The Glostavent Anaesthetic machines are intended to be used by qualified medical professionals to administer inhalational anaesthesia to paediatric and adult patients. The Glostavent Helix and Helix Duo can also deliver intermittent positive pressure ventilation at adjustable breathing rates and tidal volumes for use in theatre, post-operative ventilation, or in the Intensive Care Unit (ICU).

The machines are designed for, and suitable for, use in resource limited settings with one or more of the following:

- Erratic or intermittent power source,
- Oxygen scarceness,
- non-controlled heat and humidity environments,
- Limited skills and financial resources for maintenance

1.2 INDICATIONS FOR USE

The Glostavent Anaesthetic machines are indicated for use when a patient requires general anaesthesia, with ventilation (available with Glostavent Helix Duo)

1.3 FOREWORD.

These systems are not intended for clinical use or commercial distribution within The EU (With the following exceptions.

- Supervised training by qualified personnel.
- Deployment by Military or supportive aid agencies to field hospitals (whether within the EU or not)

This manual is intended to provide guidance on the function, performance, and user maintenance of the Glostavent® Helix Anaesthesia System. The information given in this manual is correct at the date of publication.

Separate IFU Manuals for the UPS and Oxygen Concentrator are also included and must be reviewed for specific Safety and maintenance requirements before use.

The policy of Diamedica (UK) Ltd is to continuously improve its products. Changes may be made to this manual without notice being given.

Users of the Glostavent® Helix Duo Anaesthesia System must read, understand, and follow the guidance given in this manual before using the system.

1.4 GENERAL GUIDANCE

The Need For Patient Monitoring

The Glostavent® Helix Duo Anaesthesia System delivers mixtures of gases and vapours which could cause injury or death to the patient. The effect of anaesthesia drugs on individual patients can vary so that “typical” machine settings for concentrations delivered to the patient do not necessarily ensure patient safety.

Medical conditions which contraindicate the use of a Glostavent® Helix Duo Anaesthesia System and its associated applications include any medical conditions which may contraindicate the medical procedure itself.

The only relative contraindication is if non-invasive ventilation is available, and its use is expected to resolve the need for mechanical ventilation. This should be started first as it has fewer complications than mechanical ventilation.

The ultimate responsibility for patient or procedure contraindication lies with the anaesthetist.

Pressure readings indicated on the gauge on the front panel indicate the pressure inside the bellows at the point of delivery. Downstream pressures at the patient interface may be less than this due to length and elasticity of the circuit.

It is essential that the patient's respiration and other vital functions are also monitored.

Always position the device such that all controls can be easily accessed and that it can be disconnected from the mains supply without obstruction.

Mains power supply isolation:

1. Switch off UPS.
2. Disconnect the mains supply cable from the UPS to the power socket (see Section 4).

The Glostavent Helix Duo does not include patient monitoring for ETCO₂ FIO₂, Patient airway pressure, expired volume, or PEEP. It is the responsibility of the clinician in charge to ensure suitable monitoring is in place for the patient and procedure being performed and in the environment in which it is being completed. Scales for Tidal volume, BPM and pressure are for indication (+/-10%) of delivery from the ventilator.

Daily set up and test instructions should be successfully carried out to ensure that the Glostavent® Series of anaesthetic machines are in operating condition. If any parameter or test is found to deviate from the instructions the machine should not be used, until the issue is resolved.

The Diamedica Glostavent Helix Duo utilizes atmospheric air within the delivered mixture to the patient it is therefore recommended, particularly in areas at risk of atmospheric contamination that a single use bacteria filter is used within the patient circuit. HME and breathing system filters should be medically compliant with recognized standards for use within the region of operation.

It is essential that the patient's respiration and cardiovascular status are frequently checked by the anaesthetist.

The anaesthetist is ultimately responsible for patient safety and should always have a secondary means of maintaining patient safety.

Observations of the patient must take precedence over machine settings in judging the condition of the patient.

If ether is the only volatile agent available, it must be vaporised in a different vaporiser. It must not be used with the mechanical ventilator due to the risk of explosion.

Drawover anaesthesia is contraindicated for patients below 10kg, for these patients the machine should be used in continuous flow (see section 10).

This User Manual must be stored near the product, protected from anything, which could compromise its integrity and legibility.

Reporting serious incidents

Any serious event that occurs in relation to the system is to be reported to the manufacturer as well as the Competent Authority in the country where the device is used.

1.5 WARNINGS

- The Diamedica Glostavent Anaesthesia Systems delivers mixtures of anaesthetic agents and gases to the patient and the device should be monitored at all times.
- It is essential that the patient's respiration and other vital functions are also monitored.
- The ultimate responsibility for patient safety remains with the operator, who should always have a secondary means of maintaining ventilation.
- Observations of the patient must take precedence over machine settings in judging the condition of the patient.
- **The system is only intended to be used by Qualified Anaesthetists.**
- Observe patient for any signs of allergic response to anaesthetic agent
- Only use the system on patients who are medically fit for anaesthesia, and infants of 10kg or more
- Use of a single-use biological filter is strongly advised to protect the ventilator from contamination that could infect the next patient.
- Ensure that the system is maintained and cleaned as per this IFU
- In the event of low pressure alarm without obvious cause, perform leak test (Assembly and test before use)
- Assemble and test the system before use
- **NO MODIFICATION OF THIS EQUIPMENT IS PERMITTED.**
- To avoid the risk of electric shock, this equipment must only be connected to a mains supply with protective earth." Use only approved cabling supplied with system.
- A Safe Working Load S.W.L. 25kg should be applied as follows:
A Back up Oxygen cylinder may be located and securely fastened in the Cylinder support cradle at the rear of the device up to a maximum gross weight of 22kg.
A patient monitor, up to a weight of 3kg may be placed on the top shelf when in use. This must not be left in place if moving the device to a new location.
- To avoid the risk of tipping please ensure that any movement or adjustment of the devices position is made by contact made at table height or below and not by pushing the top of the machine.
- Do not operate at altitudes above 2000M.
- Ensure unit is suitably situated on a level surface free from standing and dripping liquid.

- Do not cover the device whilst in use or place in a position that affects its effective operation e.g., do not obstruct air inlets or equipment ventilation grilles.
- Do not add any attachments or accessories that contravene the instructions for use, as this may cause the unit to function incorrectly, leading to the risk of a serious deterioration of health of the patient.
- **Do not** initiate use, when not connected to mains power, if the Green power light is flashing (Battery life less than 2 hours). Connect unit to power source to recharge.
- The patient circuit tubing is Non-conducting (Applied Part). DO NOT replace with conducting/anti-static tubing.

1.6 ESSENTIAL PERFORMANCE

The device's primary design function and therefore Essential Performance is to enable and empower the Anaesthetist to maintain a stable state of anaesthesia and ventilation in their patient (Items marked in Bold below).

1. **Continuous flow of oxygen mixture** – mixture level is mechanical via flow meters. Generation of an alarm from the oxygen concentrator if supplied oxygen level drops below specifications level*
2. **Stable Delivery of anaesthetic agent** (this is a mechanical setting)
3. **Linear peak pressure delivery** (Within specified tolerances) Low and high airway circuit pressure will be detected, and an alarm generated*
4. **Stable delivery rate (BPM)** (Within Specification tolerances)
5. Failure of the UPS will result in an alarm**
6. Failure of the Oxygen Concentrator will result in an alarm**

The devices' ability to maintain essential performance is validated by completion of actions listed in the below listed sections.

Section 3 The component parts of the Glostavent Helix Duo

- Periodic (Monthly) Circuit integrity check
- Oxygen analyser – Start up calibration

Section 6 Test procedure before use

Section 10 Alarms – Testing alarms

Note - Reference should also be made to the manufacturer IFUs for the Oxygen Concentrator and UPS

Note - patient monitoring takes precedence over machine settings

1.7 Clinical Benefit of the Glostavent System

The clinical benefit of use of the Glostavent system is anaesthesia – which is essential for surgery and treatments where the patient should be immobile and unconscious. Anaesthesia is not a treatment, but is an essential enabler of treatments that are required to sustain life or improve the health and or quality of life. The Glostavent systems provide a controlled mechanism to administer anaesthetic agents, and ventilate the patient while under anaesthesia.

Table of Contents

1	READ THIS SECTION FIRST.....	2
1.1	INTENDED USE.....	2
1.2	INDICATIONS FOR USE	2
1.3	FOREWORD.....	2
1.4	GENERAL GUIDANCE	2
1.5	WARNINGS	4
1.6	ESSENTIAL PERFORMANCE	6
2	INTRODUCTION.....	8
2.1	SPECIFICATIONS	9
2.2	CLEANING, GENERAL MAINTENANCE AND DISPOSAL	11
2.3	THE PRINCIPLE OF THE GLOSTAVENT® HELIX	17
3	THE COMPONENT PARTS OF THE GLOSTAVENT HELIX.....	18
3.1	THE BREATHING SYSTEM.	18
3.1.1	Features of the Drawover system.	21
3.2	THE OXYGEN CONCENTRATOR.....	25
3.2.1	Frequently asked questions on the oxygen concentrator.....	26
3.3	THE GLOSTAVENT® HELIX VENTILATOR	27
3.3.1	Frequently asked questions on the ventilator	28
3.3.2	Periodic (Monthly) Circuit integrity check.....	29
3.4	OXYGEN ANALYSER	30
3.5	AVS30 AUTOMATIC VOLTAGE PROTECTION UNIT	33
4	THE GLOSTAVENT HELIX - CONTROL AND OPERATION	35
5	THE GLOSTAVENT HELIX ALTERNATIVE POWER SOURCES.....	44
5.1	UPS:	44
5.2	OXYGEN CYLINDER BACK UP	44
5.3	ADDITIONAL VENTILATION BACK UP	44
5.4	MANUAL VENTILATION	45
6	ASSEMBLY AND TEST PROCEDURE BEFORE USE	46
7	USE OF THE GLOSTAVENT® HELIX ON ADULTS.....	48
8	USE IN PAEDIATRIC PATIENTS.....	51
9	PEEP (positive end expiratory pressure).....	52
10	ALARMS	53
10.1	Testing alarms	54
11	ELECTROMAGNETIC COMPATIBILITY.....	55
12	TROUBLE SHOOTING	58
13	SYMBOLS GLOSSARY.....	61

2 INTRODUCTION

In many parts of the world anaesthetics are administered in situations far removed from those found in modern, well-equipped hospitals in wealthy countries. There may, for example, be no oxygen, electricity, or technical support. In these circumstances, the latest sophisticated anaesthetic machines with their delicate monitoring devices are unable to function and are rapidly consigned to the graveyard of anaesthetic equipment which litters the developing world.

Anaesthetists working in such environments need equipment which goes beyond the standards of those required for hospitals in rich countries. Equipment is needed that has been specifically designed to meet the additional requirements of harsh environmental conditions and limited infrastructure and that will continue to function in those prevailing conditions. When advice has been sought from anaesthetists working in these areas the following properties have been most frequently requested:

The anaesthetic machine should be:

1. Easy to understand and operate.
2. Robust and not easily damaged
3. Inexpensive to purchase and economical to run.
4. Maintained using locally available skills.
5. Safe to use in the absence of expensive electronic monitoring equipment.
6. Versatile, so that the same machine can be used on any size of patient, with a variety of volatile agents, in either draw over or continuous mode, both as an anaesthetic machine in the operating room and a ventilator in a recovery or intensive care unit
7. Able to continue operating without interruption in the absence of oxygen or electricity.
8. Be resilient to unstable or intermittent mains power supplies.

The Glostavent[®] Helix Duo anaesthetic machine has been developed to meet these requirements and the needs of anaesthetists working in difficult environments.

This manual has been prepared to provide practical guidance for those using the Glostavent[®] Helix Duo anaesthetic machine. It should only be operated by experienced anaesthetists who have received specific training in its use and are fully competent in its operation.

2.1 SPECIFICATIONS

The Glostavent Helix Duo Anaesthesia machine is suitable for adult and paediatric use. The specifications for Glostavent Helix Duo are provided in the table below.

		Glostavent HELIX DUO (GVHELIX2)
Feature		System
Dimensions	Height	145cm
	Width	66cm
	Depth	54cm
Weight		102kg
Electrical Safety classification		Class I Equipment (when connected to AC mains)
Power input		100-240V AC, 600W
Operating Environment	Temperature	5 - 40° C
	Humidity	35% - 93% RH
	Altitude	79 – 106 kpa
Storage Environment	Temperature	-10 - +45° C
	Humidity	15% - 93% RH
	Altitude	79 – 106 kpa
Maximum operational altitude		< 2000m
Device lifetime		Minimum of 5 years
Non-sterile device, not to be sterilised; continuous operation; suitable for use in an oxygen rich environment		
Feature		Ventilator
Tidal Volume **		100 – 1200ml
Inspiratory/Expiratory Ratio		1:2
Inspiratory pressure range **		8 – 50cm H ₂ O
Triggered breathing control **		1 – 5cm
Breaths per minute **		6 – 40
Alarms (Ventilator)		High Pressure >60cmH ₂ O (LED/Audible) Low pressure / Disconnect <2cmH ₂ O (LED/Audible) Low Battery life <2 hours (Flashing Green LED) Battery failure (Flashing Green LED / Intermittent audible)
Pressure relief		>66cmH ₂ O
Drive pressure/volume		> 20psi /<75psi @ >5l/min
PEEP; circuit dependent		0 – 20 cm H ₂ O
Oxygen monitor		in-line oxygen concentration measurement and display
Power Supply		100-240V AC, 0.35A charger for internal 12volt Sealed Lead Acid battery. Class II.
Internal rechargeable battery		>300 hours

Safety	Charger certified to IEC 60601-1, IEC 60601-1-2
Feature	Vaporiser
Low inspiration resistance	<0.6kpa
Suitable for Drawover and continuous flow	Yes
Anaesthetic agent	Isoflurane, Halothane or Sevoflurane
Capacity	150ml
Agent percentage	ISO / HAL 0 – 5% SEV 0 – 8%
Oxygen Concentrator	
Flow rate oxygen (l/m)	0 – 10 l/m
Flow rate air (l/m)	0 – 10 l/m
Alarms	High/Low pressure, Low flow, Low oxygen, Power fail
Power consumption	600 W Max
Safety	Certified to IEC 60601-1, IEC 60601-1-2
UPS	
Type	2 KVA double on-line
Circuit breaker	16 A
Standard operating input range	230VAC, 50Hz
Input tolerance	110-330VAC 45/65Hz
Onboard Batteries	12v 12Ah (Total) x 4
Conforms to	EN62040-1, EN62040-2
Voltage Surge Protection	
AVS30	Protect against: High voltage, Low voltage, Spikes / surges, Powerback surges

The gas flow and volume specifications are represented as SATP it should be noted that the use of alternative patient circuitry and extreme atmospheric conditions can influence the delivered values.

** Control scales are indicative. Delivered condition accurate within +/-10%

*** Delivered concentration accurate within ±20 % of set value for concentrations (volume fraction) greater than 1 % and ±50 % of set value for concentrations of 1 % or below, at 20° C.

2.2 CLEANING, GENERAL MAINTENANCE AND DISPOSAL

The anaesthesia machine usage should be clearly logged and recorded to assist maintenance and cleaning activities.

This can be done in a format suitable to the user or in a format as shown below.

Date	Task	Time on	Time off	Concentrator hours	Agent	Comments / Completed tasks
	① Patient use ② Maintenance ③ Cleaning					

Suggested usage log for Glostavent Helix Duo Anaesthesia machine

a) Cleaning

The anaesthesia workstation should be cleaned daily by wiping down with a damp cloth, care should be taken to ensure that any sharps have been removed and disposed of safely before this is done.





Ensure unit is dry free from moisture after wiping. Pay attention to warning labels (As shown below).



Patient safety is the primary concern of the Clinician and infection control is critical to ensuring the safety of medical procedures. Appropriate cleaning and disinfection is essential after each patient usage.

(i) Breathing circuit

Each Glostavent Helix Duo Ventilator is supplied with a reusable breathing circuit. as these items may come in contact with the patient and can therefore potentially pass infectious agents from one patient to another if used improperly, the reusable breathing tubing and patient valve provided with the anaesthesia machine should be cleaned and disinfected according to your hospital's infection control procedures. If no bacteria filter is used, then the entire circuit should be cleaned and disinfected after each patient or after any contamination event involving the breakdown of the completed circuit. Refer to table below.

Component	Image	cleaning requirements	Frequency	Comments
Patient limb		Wash in bleach solution, rinse and dry in line with hospital's infection control procedures	Weekly	Examine for damage, replace if necessary.
Self inflating bag		Wash in bleach solution, rinse and dry in line with hospital's infection control procedures	Weekly	Examine for damage, replace if necessary.
Limb to self-inflating bag		Wash in bleach solution, rinse and dry in line with hospital's infection control procedures	Weekly	Examine for damage, replace if necessary.
Patient 'Y' Piece		Wash in bleach solution, rinse and dry in line with hospital's infection control procedures	Weekly	Examine for damage, replace if necessary.

Any bacteria filters and other single-use items provided should be discarded after one use since they are not designed to be reprocessed.

(ii) Filters

It is very important to check the condition of the particulate filters on the rear of the Glostavent panel and on the rear of the concentrator, at least once every week, and more often if the environment is very humid and dusty. If the air filter is dirty then it must be cleaned with by washing in clean soapy water and then rinsed, removing as much water as possible and replacing.



Any bacteria filters and other single-use items provided should be discarded after one use since they are not designed to be reprocessed.

(iii) Vaporiser

The Glostavent Helix DUO has a combination of vaporisers for two of a possible three anaesthetic agents. If one of those agents is Halothane there is a possibility of the accumulation of the stabilising agent in that vaporiser. This is why the Halothane vaporiser is always downstream of other vaporisers to avoid Thymol

migrating to the other vaporiser. Periodic use of the upstream vaporiser will minimise the possibility of thymol accumulating, however if the Halothane vaporiser lever becomes stiff you can perform the following to loosen the lever:

1. Remove the vaporiser from the control panel and set to zero.
2. Turn it upside down, and shake it vigorously followed by turning the lever until it becomes loose.
3. When the lever loosens, it should be drained and rinsed with fresh agent.
4. Attach the vaporiser to the control panel and fill with fresh halothane.

The vaporiser should not require recalibration. Any Operational calibration should only be done following consultation with manufacturer.

b) Maintenance

The Helix Ventilator is designed to require minimal maintenance.

Patient circuit components should be inspected after each use and cleaning operation to ensure their integrity. If any degradation of a component is observed, then it should be replaced. It is recommended that at least one full set of patient circuit components is available to eliminate the need for any downtime of the ventilator.

WARNING

The patient circuit tubing is Non-conducting (Applied Part). DO NOT replace with conducting/anti-static tubing.



A full list of spares is available by contacting Diamedica - support@diamedica.co.uk

If the anaesthetist has any concerns relating to cleaning or maintenance or the function of the Glostavent they should contact the manufacturer.

c) Replacement of Control panel battery.

In the event that a new battery is required, this must be done by a suitably competent service technician. The battery is a 12V 10Ah VRLA Battery. This is available by contacting Diamedica support@diamedica.co.uk

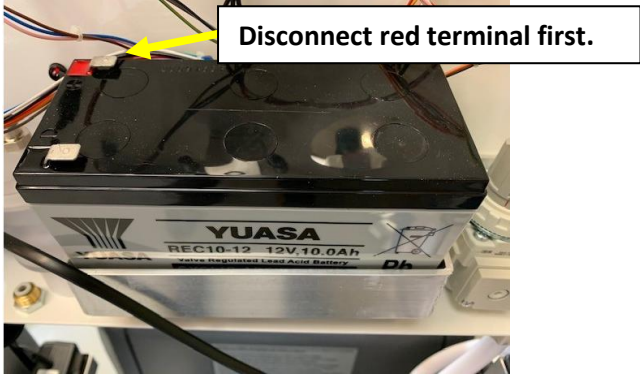
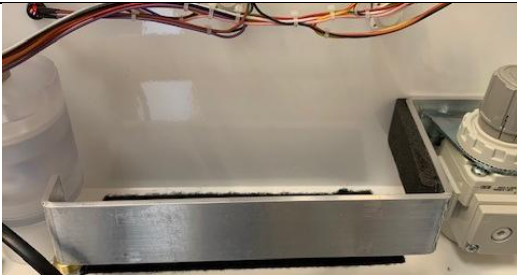
To remove the Control Panel battery.

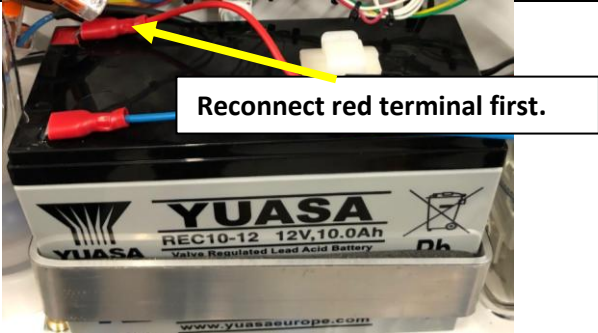
<p>Before removing the battery disconnect the machine from the mains power. And ensure that the UPS is switched off.</p>	
<p>Once disconnected from mains power disconnect both terminals on the battery removing the live (Red) first.</p>	
<p>Once the battery has been disconnected lift out the battery.</p>	
<p>Replace with a new 12 volt 10.0Ah battery.</p>	
<p>Once the battery has been replaced reconnect the battery connecting the live terminal (Red) first.</p>	

Replacement of control board fuse and / or 12v circuit safety fuse.

If it is identified that the onboard fuse protection for the control board has blown then please contact Diamedica

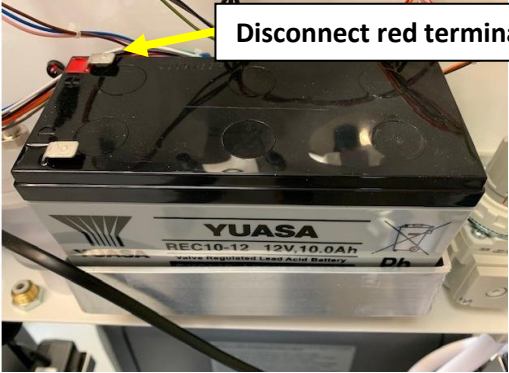
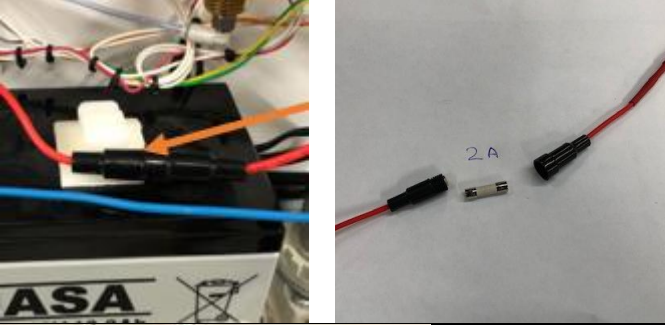
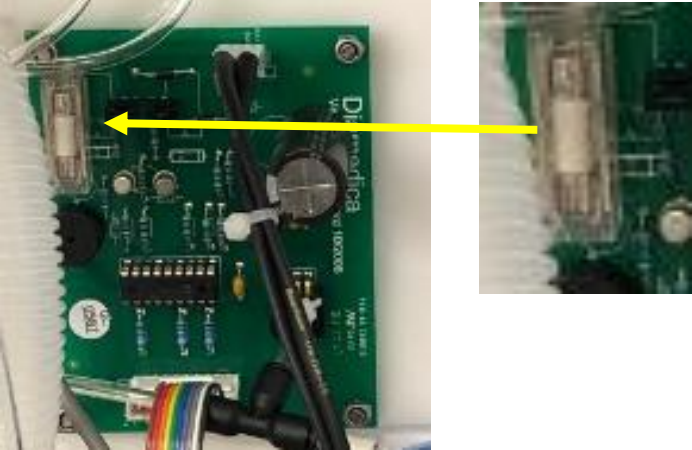
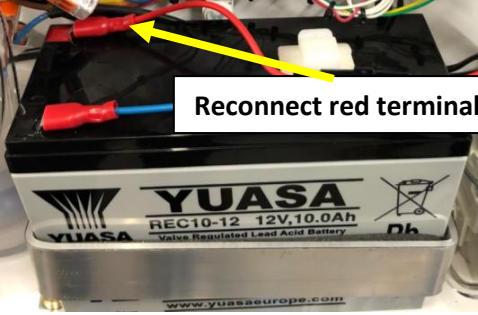
Before removing any fuses disconnect the machine from the mains power. And ensure that the UPS is switched off.	
Once disconnected from mains power disconnect both terminals on the battery removing the live (Red) first.	
<u>12v circuit fuse</u> Remove fuse from plastic holder and unscrew to remove fuse and replace with a 2 Amp fuse.	
<u>Control board fuse</u> To remove circuit board fuse which is located in the top left-hand corner of the circuit board and pull to remove. Once removed replace with a 2 Amp fuse.	
Once the battery has been replaced reconnect the battery connecting the live terminal (Red) first.	

Non serviceable components.

The PC Control board and loom contained within the unit are non-serviceable please contact Diamedica for any enquiries relating to these components.

✉ Email: support@diamedica.co.uk

📞 WhatsApp: +44 (0) 7716 503156

d) Consumables and spares

All patient circuit consumables used with the Glostavent anaesthesia machine must:

- Be oxygen compatible,
- Be biocompatible,
- Comply with international medical device regulations ie EU MDR 20172/745 or, FDA. Conical connections must be in accordance with ISO 5356-1; Anesthetic and Respiratory Equipment – Conical Connectors

e) Method for disposing of the device.

If the product is returned to the manufacturer at the end of its life the company will ensure disposal in line with the Waste Electrical and Electronic Equipment Directive (WEEE) 2012/19/EU

2.3 THE PRINCIPLE OF THE GLOSTAVENT® HELIX DUO

The Glostavent® Helix Duo is a free-standing anaesthetic machine which has been specifically designed to facilitate the administration of inhalational anaesthesia in difficult environments. It is easy to understand and operate, economical to run and can be maintained and serviced using locally available skills. Above all, it can continue to function, without interruption, if either the oxygen or electricity supply fails.

The Glostavent® Helix Duo principal components which make this possible are:

1. A low resistance breathing system and vaporisers which can function in the absence of pressurised oxygen.
2. A ventilator which is gas driven and can function in the absence of electricity.
3. An oxygen concentrator which produces oxygen and air for the patient to breathe and oxygen to drive the ventilator.
4. An integrated method of manual assisted ventilation that can be taken to the patient's side.
5. Oxygen analyser for indication of oxygen concentration being delivered to the patient.

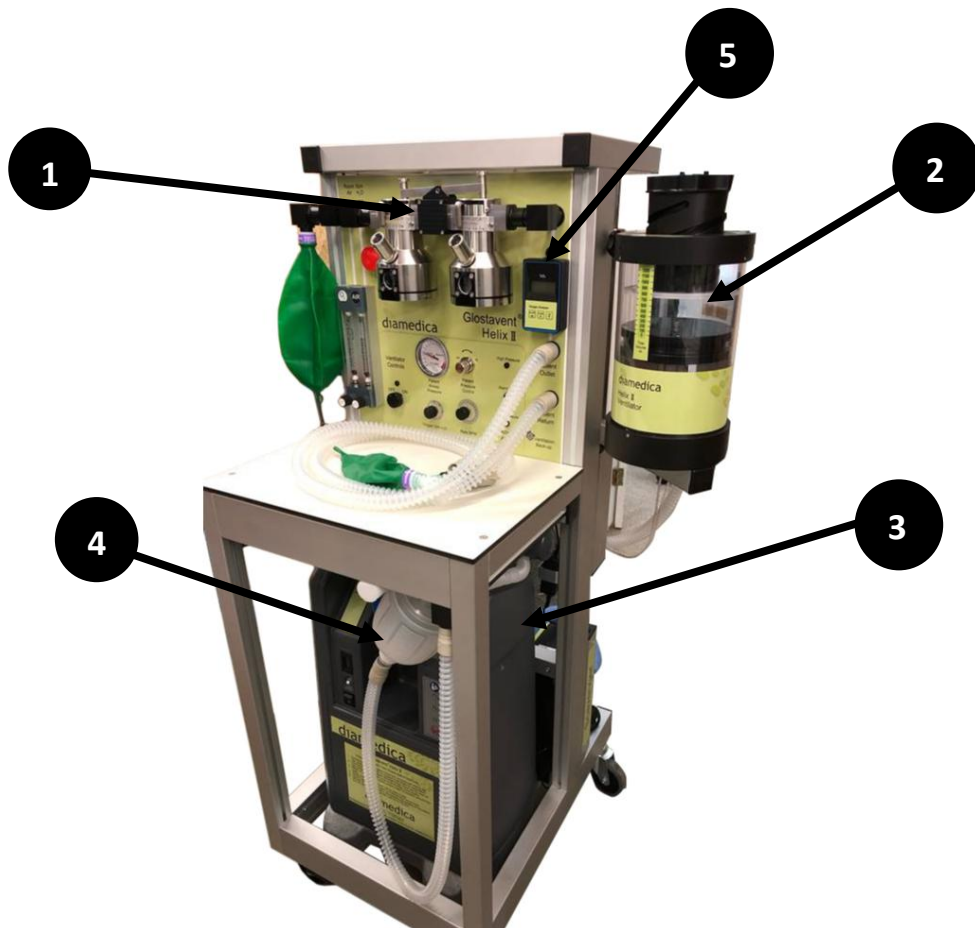

3 THE COMPONENT PARTS OF THE GLOSTAVENT HELIX DUO

3.1 THE BREATHING SYSTEM.

Before a volatile anaesthetic agent can be administered to a patient it must first be vaporised. A carrier gas containing oxygen passes through the chamber of a vaporiser where vaporisation occurs, and the resulting mixture is delivered to the patient.

Pressure Gradient



In order for the carrier gas to pass through the vaporiser there must be a pressure gradient between entry and exit ports of the vaporisers. The carrier gas must therefore either be PUSHED through by positive pressure from upstream or DRAWN through by negative pressure from downstream.

In the standard continuous flow type of anaesthesia machine, the carrier gas is PUSHED through the vaporiser by gases under pressure. Under normal conditions, i.e. when oxygen is available, this system works well but there is one serious disadvantage. It is entirely DEPENDENT ON AN UNINTERRUPTED SUPPLY OF PRESSURISED OXYGEN. If the oxygen supply fails, as it frequently does in many parts of the world, a continuous flow type of anaesthetic machine cannot function.

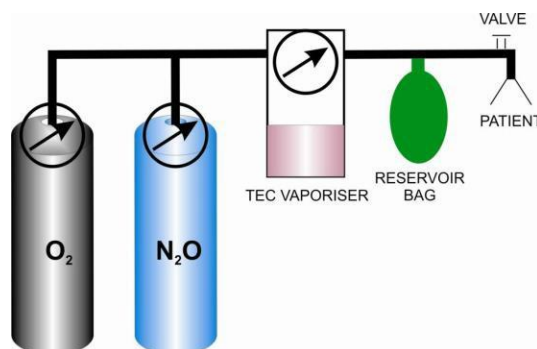

By contrast in DRAWOVER anaesthesia the carrier gas is DRAWN over the vaporiser by negative pressure generated by the patient's inspiration. The great advantage of draw over anaesthesia is that it can still be administered EVEN IF THE OXYGEN SUPPLY FAILS. In this situation room air, containing 21% oxygen, can be used as the carrier gas for the volatile agent which is supplemented with oxygen if available.

The Glostavent® Helix Duo can function as a continuous flow machine when gases are provided by the concentrator or an auxiliary source. However, if the electricity fails and there is no auxiliary 'cylinder' oxygen available it will default to a drawover machine in order for anaesthesia to continue safely.

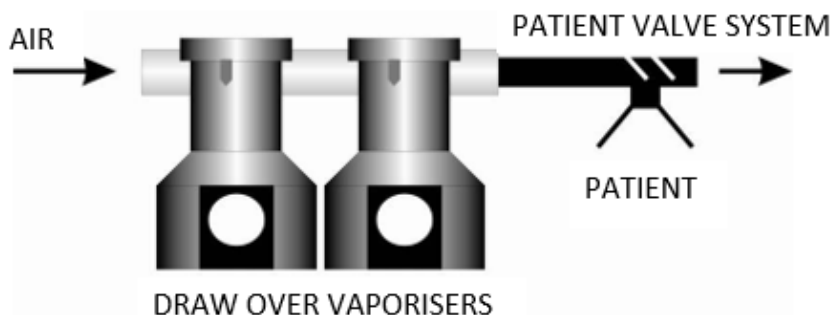

Because of the frequency of failure of the oxygen supply in some parts of the world the Glostavent® Helix Duo can use either a continuous flow or a Drawover breathing system.

This conversion happens automatically in the event of gas failure or Drawover can be used in order to conserve both oxygen and anaesthetic agent. This is described further in later sections of the manual.

The Diamedica vaporisers output is consistent in both modes, the output from other Drawover vaporisers may not be suitable for both these modes.

The flow capabilities of the draw-over vaporizer meet the requirements of ISO 18835:2015 and can operate consistently up to an intermittent peak inspiratory draw of 35 L/min. Typical capabilities @ 6l/min are represented in the graphs below.

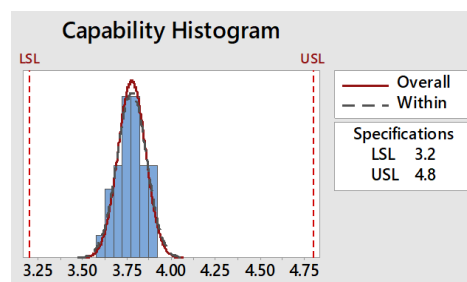
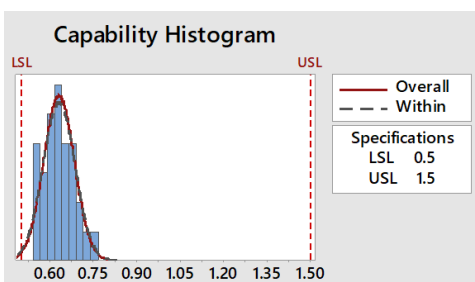
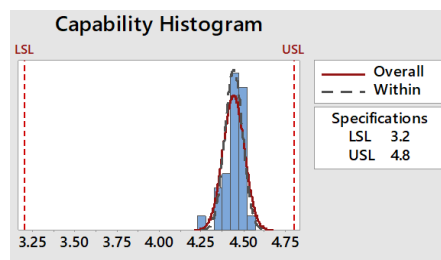
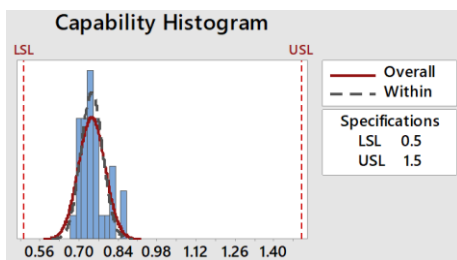

The effect of temperature on agent delivery

The Vaporizers deliver specified agents, Sevoflurane and Isoflurane. The delivery concentration of these agents will be affected by the ambient temperature of the environment in which they are being utilized. The vaporizer scales will remain accurate between 20° - 30° however increasing ambient temperature will cause an increase in delivered agent concentration and should be considered in any adjustments. The below graphs give a typical indication of the expected effect of output in comparison to increased temperatures.

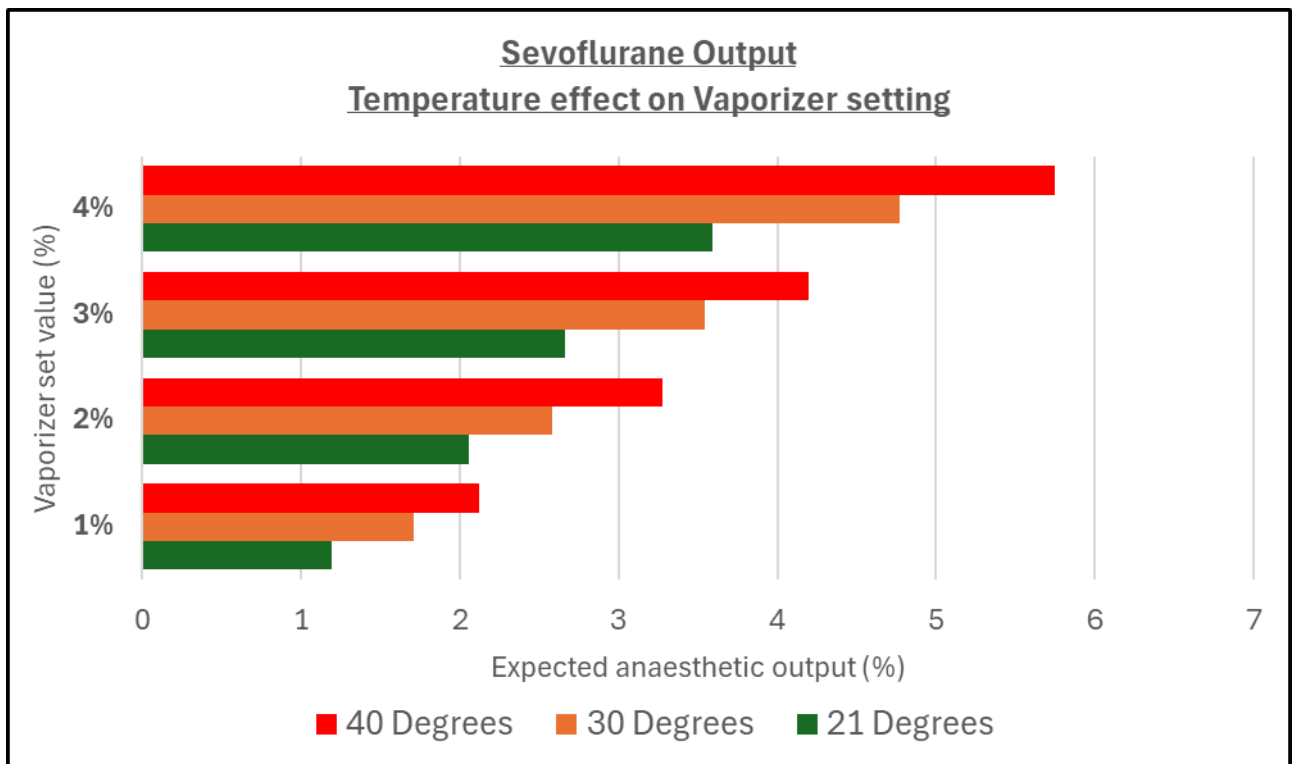
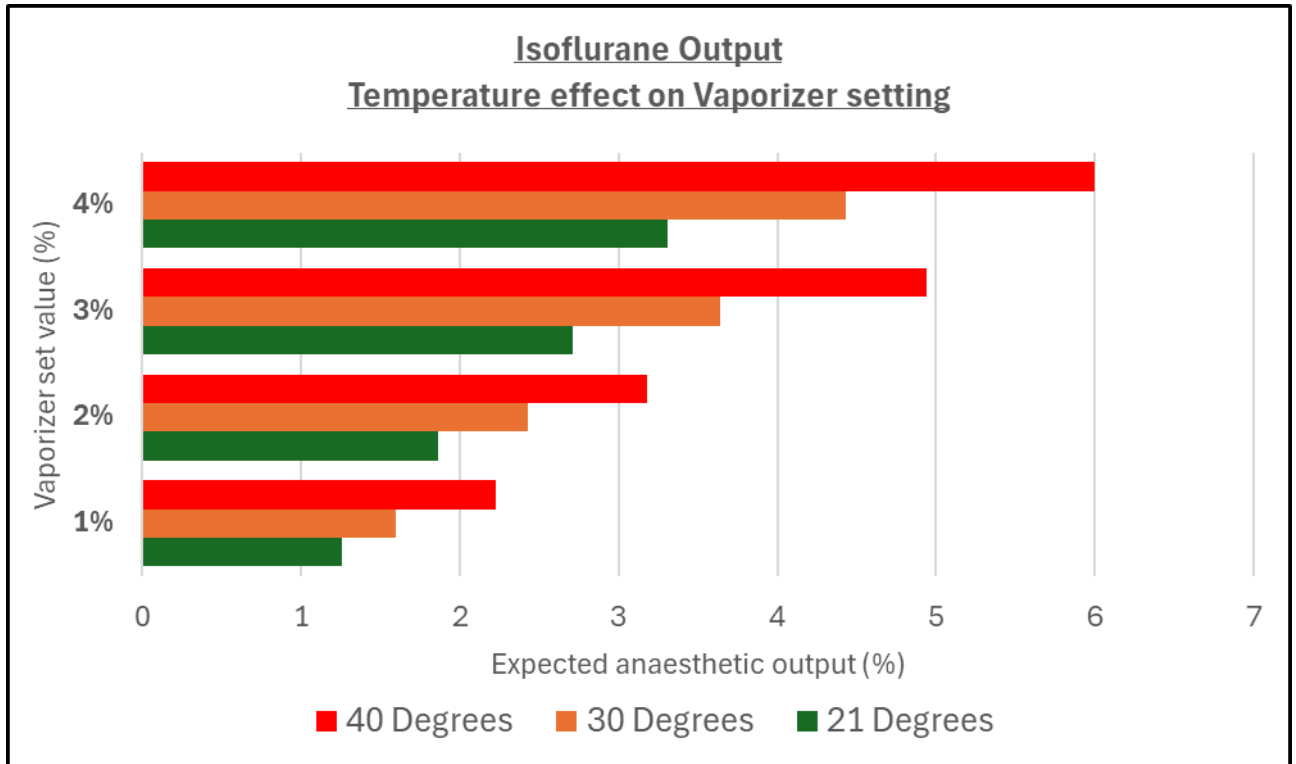

3.1.1 Features of the Drawover system.

In its simplest form, a Drawover system has the following features:

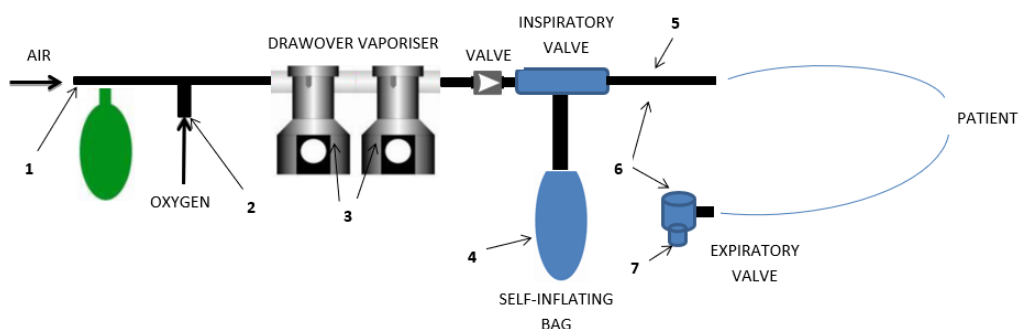

- (1) A reservoir tube with an open end through which air is entrained during inspiration.
- (2) A side port for supplementary oxygen, if available.
- (3) A vaporiser with a low resistance to breathing, such as the Diamedica vaporiser above. (The standard plenum type vaporiser, such as the Selecta-tec, is unsuitable for Drawover anaesthesia because the resistance is too high).
- (4) A self-inflating bag for I.P.P.V. with a valve to ensure the anaesthetic mixture moves towards the patient and cannot re-enter the vaporiser.
- (5) Inspiratory tubing leading to the patient.
- (6) A non-rebreathing valve system that ensures that, during inspiration, the anaesthetic mixture is not diluted by atmospheric air and that, during expiration, the expired gas cannot re-enter the system and lead to re-breathing. The valve can function with either spontaneous or controlled ventilation.
- (7) Expiratory port leading to a scavenging system if available.

The function of the reservoir tube is to store the supplementary oxygen during the phase of expiration so that it is not wasted and is included in the patient's next breath. This enables satisfactory inspired oxygen concentrations to be achieved with minimal flows of supplementary oxygen.

In a simple Drawover system the reservoir consists of a one metre length of corrugated anaesthetic tubing. While this is satisfactory during normal breathing it is less satisfactory during hyperventilation, for example as occurs during pre-oxygenation. This is because, when respiration is increased, more air is drawn into the reservoir and the oxygen is diluted. To increase the efficiency of the Drawover system the reservoir has been modified for the Glostavent® by three additions (see diagram below).

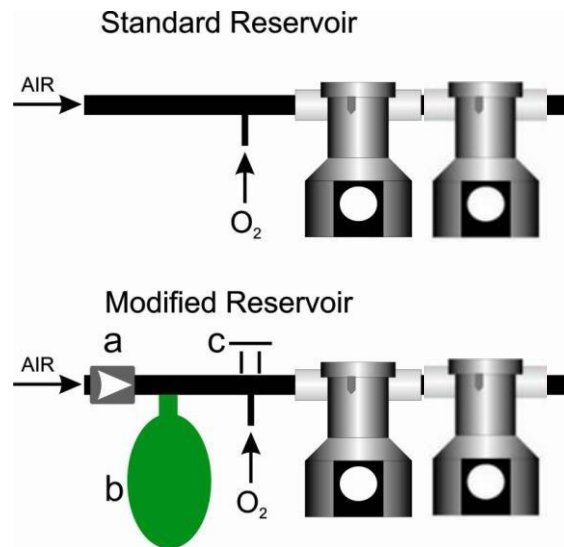

- (a) A non-return valve at the open end to prevent spillage of oxygen
- (b) A 2ltr reservoir bag to increase the volume of the reservoir. Movement of the reservoir bag also provides an indication of the rate and depth of respiration.
- (c) An over pressure valve set at 5 cm H₂O to prevent over-distension of the reservoirbag.

The modified reservoir conveys one other important advantage. It enables the Glostavent® Helix Duo to be used for both *continuous flow* and *Drawover* anaesthesia simply by adjusting the rate of gas flow in relation to the patient’s minute volume.

DRAWOVER MODE. If the patient’s minute volume leaving the reservoir exceeds the supplementary oxygen flow entering the reservoir, the pressure in the reservoir falls below atmospheric, air is drawn in through the open end of the reservoir tube and the system is in Drawover mode.

CONTINUOUS FLOW MODE. If the supplementary oxygen flow rate is increased until it exceeds the patient’s minute volume, the pressure in the reservoir rises and the system automatically transfers to continuous flow mode. The anaesthetic circuit provided is suitable in either mode and should not be changed. Unless the machine is to be used for paediatric patients under 10kg using a Mapleson F (Ayres ‘T’ piece circuit using the fresh gas flow recommended for that particular system. A one-way valve after the vaporiser on the Glostavent Helix Duo prevents backflow through the system when these circuits are in use.

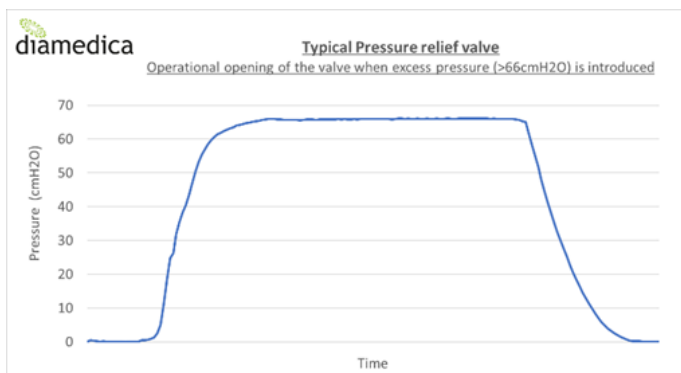

Patient circuit protection.
Relief valve characteristics

The circuit may contain pressure up to 66 cmH₂O (This will be under alarm conditions at greater than 60cmH₂O) After which point the relief valve will crack and vent.

3.1.1.1 Frequently asked questions on the breathing system.

Q. What are the disadvantages of the Drawover system?

A. (1) In earlier systems it was difficult to achieve high FiO₂ levels during hyperventilation such as during pre-oxygenation. This is because additional air is sucked into the reservoir, diluting the oxygen. This problem has been largely alleviated by the introduction of the modified reservoir.

(2) Gaseous induction requires an airtight seal at the facemask so that sub-atmospheric pressure can be generated. This may be difficult in un-operative children or in the presence of facial injury. With the modified reservoir this problem can be solved by conversion to continuous flow mode.

Q. How is the draw over system flushed with oxygen in an emergency situation?

A. There are two methods of achieving this:

a) The vaporiser is turned off and the oxygen flow meter is set to deliver the maximum flow rate. The inspiratory limb of the circuit is briefly disconnected from the patient while the self-inflating bag provided in the patient circuit is compressed rapidly several times to purge the circuit of the anaesthetic mixture. It is then re-connected, and the lungs ventilated with oxygen.

b) The vaporiser is turned off and the inspiratory limb of the circuit is briefly disconnected from the patient while the oxygen flush button on the Glostavent® control panel is depressed for 10 seconds to purge the circuit of the anaesthetic mixture. The inspiratory limb is then re-connected, the oxygen flowmeter is set to maximum and the lungs ventilated with oxygen.

Q. Does the Diamedica vaporiser have any advantage over a standard plenum type vaporiser?

- A. (1) It has a low resistance allowing patients to breathe spontaneously through it.
(2) The same vaporiser can be used for a variety of volatile agents.
(3) It is less expensive.
(4) It has a simple design and can be serviced and maintained by local hospital personnel.

Q. Which volatile agents can be used with the Diamedica vaporiser?

A. The scale is calibrated for both Halothane and Isoflurane. A Sevoflurane version of the vaporiser is also now available. If ether is the only volatile agent available it must be vaporised in a different vaporiser. It should not be used with the mechanical ventilator due to the risk of explosion.

Q. How is the vaporiser filled?

A. The vaporiser is filled by unscrewing the filler cap and pouring the agent directly from the bottle into the chamber. No special filling device is required although a funnel is available if needed. If the vaporiser requires filling during anaesthesia then the vaporiser must be turned off while being filled.

The Sevoflurane vaporiser is filled using a key fill connection specific for sevoflurane, this is done by sliding the bottle filler into the vaporiser and pushing down to fill. The vaporiser must be switched on while being filled.

Q. How can the vaporiser be emptied completely before a different agent is used?

A. The door on the back of the control panel is opened and the screw supporting the vaporiser is located so that the vaporiser can be unscrewed and removed. The filler cap is removed, and the vaporiser inverted over the bottle until fully drained using the funnel if required. To remove the residual contents, the vaporiser is replaced, the dial turned on fully and gas is blown through the chamber for several minutes until the vapour can no longer be detected.

Q. How is the breathing circuit cleaned between patients?

A. The risk of contamination of the anaesthetic tubing is diminished by virtue of the open circuit system, although bacterial filters should be used if available. The circuit should be washed in warm soapy water between patients. For other circuits and valves please seek the advice of the manufacturer.

Q. How can respiratory movements be monitored in Drawover anaesthesia?

A. Movements of the reservoir bag can be used as a guide to the depth and rate of respiration when using the Glostavent® Helix Duo.

Q. What is the most effective way of pre-oxygenation of patients?

A. Satisfactory pre-oxygenation can be achieved with the Glostavent® Helix Duo Drawovercircuit using an oxygen flow rate of 10 l/min.

3.2 THE OXYGEN CONCENTRATOR

Cylinders of oxygen are expensive and may run out whereas atmospheric air costs nothing and does not run out. For this reason, atmospheric air is used as the principal source of oxygen for the Glostavent® Helix Duo delivered by means of an oxygen concentrator.

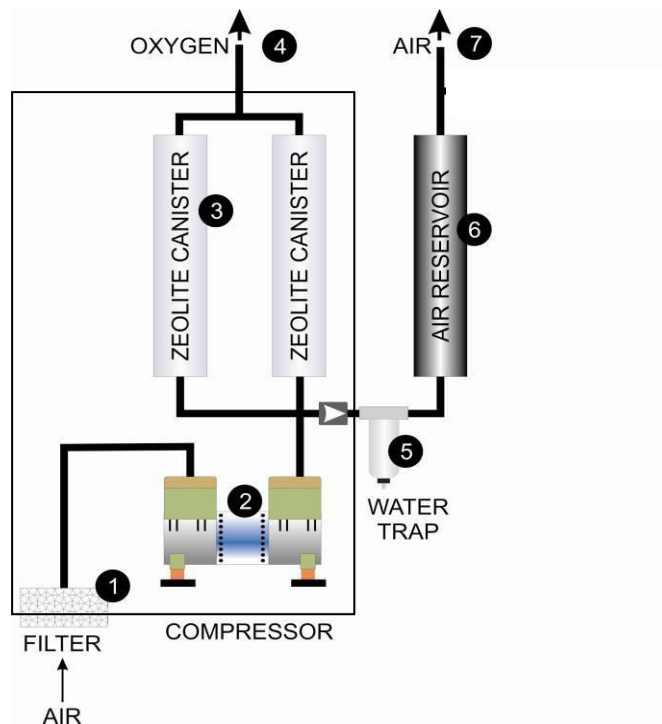

The oxygen concentrator is a device that can produce a supply of oxygen from atmospheric air. The air is drawn into the concentrator through a filter (1) and then compressed (2) to a pressure of 20 psi (140 KPa). Some of this compressed air then passes through canisters containing granules of zeolite (3) where the nitrogen is absorbed, and the residual oxygen delivered to the patient or used to drive the ventilator (4). The remainder of the compressed air passes through a water trap (5) which enables the water formed by condensation to be automatically released at regular intervals so that it cannot obstruct the flow. It then enters the compressed air reservoir (6) from which it is available for the breathing circuit (7).

The concentrator is able to deliver simultaneously up to 10 litres/min of oxygen and 10 litres/min of air for the patient and some of the oxygen is also used to drive the ventilator before recycling this drive oxygen into the patient circuit. The electricity consumption is only 590 Watts and is the same regardless of the flow of gases.

3.2.1 Frequently asked questions on the oxygen concentrator.

Q. How often does the zeolite need changing?

A. Unlike soda lime, zeolite does not need changing as the granules are constantly being re-charged. The same canisters can be used for many years dependant on usage hours.

Q. Can the concentrator function at high altitude?

A. Yes. It functions in the same way whatever the altitude within specification.

Q. Can the concentrator function when the humidity is high?

A. Yes. There is a water trap in the compressed air tubing to prevent condensation causing obstruction of the tubes.

Q. Can the concentrator function in the presence of high voltage fluctuations?

A. The Concentrator is connected to the mains via a UPS system which incorporates a voltage stabiliser enabling the Glostavent[®] to function in the presence of the following fluctuations dependant on load.

(40% load) 100V~300V AC

(100% load) 176V~300V AC

Q. Is there any advantage in using the concentrator if cylinders are available?

A. Yes. Cylinders of oxygen are expensive and may run out. In contrast atmospheric air costs nothing and does not run out. Therefore, whenever possible air should be the source of oxygen via the concentrator and cylinders of oxygen kept in reserve.

Q. What are the servicing requirements of the concentrator?

A. The concentrator requires minimal operational servicing. Refer to section 2.2 and the Concentrator IFU for specific details.

3.3 THE GLOSTAVENT[®] HELIX DUO VENTILATOR

This is a time cycled, volume limited pressure generator. It is a gas driven ventilator and can therefore function largely independently of the supply of electricity. A small amount of power is required to power the electronic circuitry. This is supplied from the onboard 12v battery. This battery is recharged when the unit is connected to a mains supply.

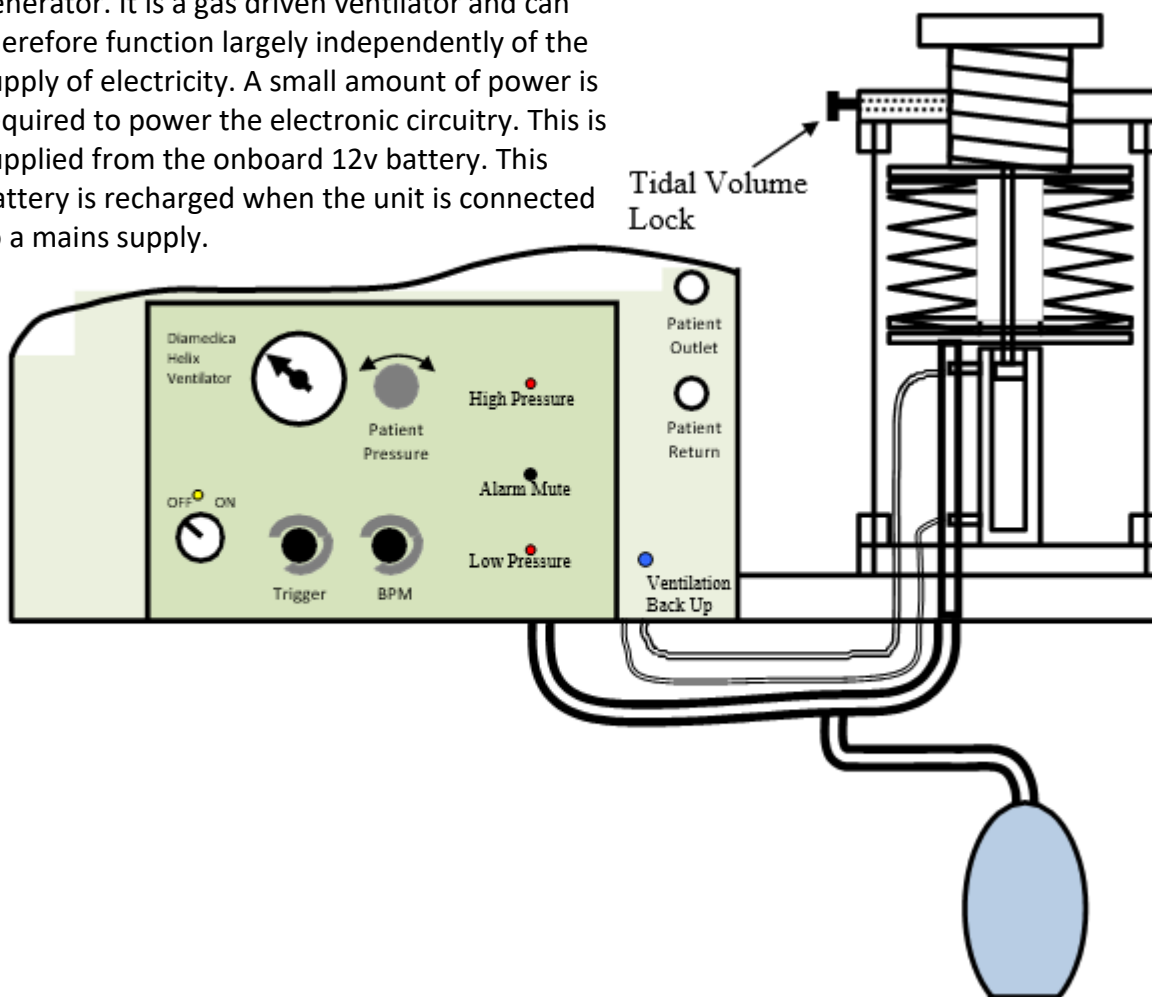

The ventilator bellows section consists of a set of bellows and a helical screw above the bellows for tidal volume adjustment.

A drive piston is mounted below the bellows and is driven upwards by the driving gas. This piston pushes the top of the bellows upwards causing the bellows to expand and fill with the gas mixture. When the control solenoid switches the gas flow the piston is driven closed compressing the bellows; a valve directs the gas mixture towards the patient.

The tidal volume range on the Glostavent Helix Duo is 100ml to 1200ml, the displaced volume over this range is accurate to +/- 10% (*Refer to note below) over the full range of possible BPM (6-40)

*The tidal volume setting is a maximum limited volume (Physical setting) and the marked value on the scales indicates the TV output with zero circuit resistance. All resistance to this including circuit tubing, PEEP valve and patient lung resistance will affect the actual delivered volume. The indicated effect of this can be seen in the table below and should be considered when setting the required delivery.

Patient observations and airway monitoring will always take precedence over machine settings.

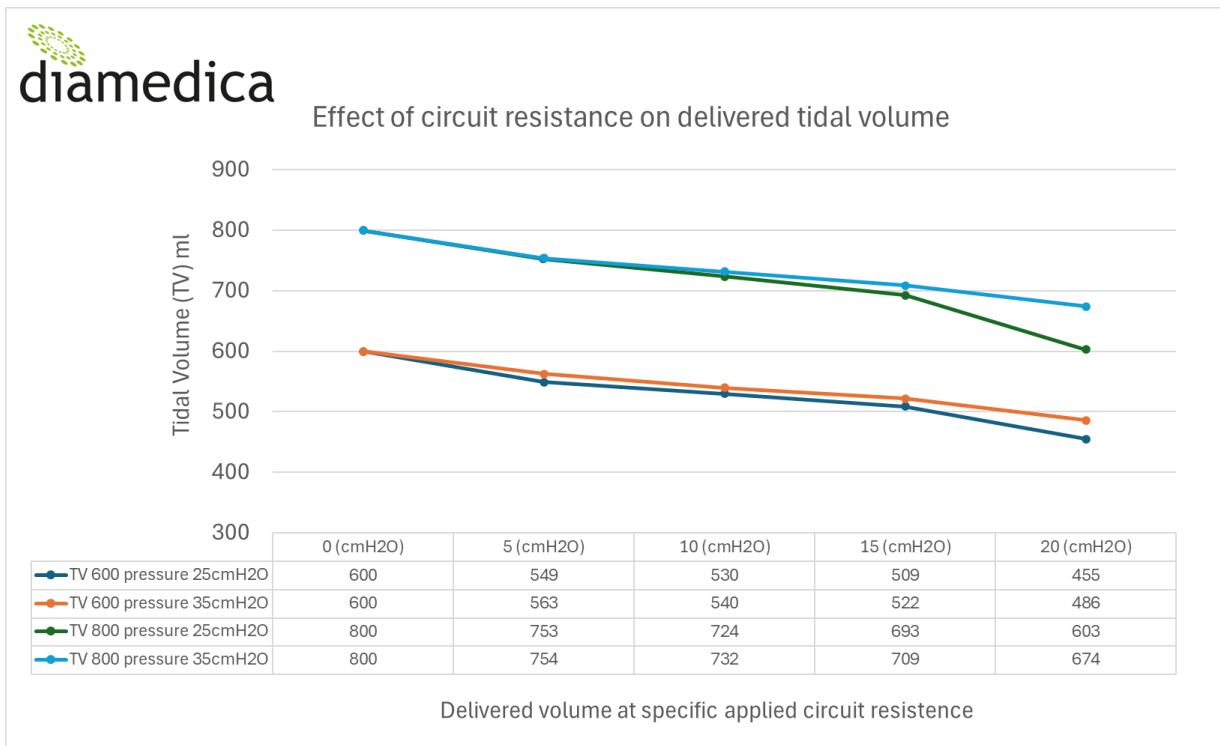

3.3.1 Frequently asked questions on the ventilator

Q. How long can the ventilator function in the complete absence of electricity?

A. Providing oxygen is available the limiting factor is the life of the battery needed for the electronic circuitry. A fully charged new battery will theoretically last for up to 300 hours. It is therefore important to keep the battery fully charged when the Glostavent® Helix Duo is not in use.

Q. Does the compression caused by the bellows cause distension of the self-inflating bag and thus a decrease in tidal volume?

A. No. The self-inflating bag is sufficiently rigid to resist significant expansion during inflation of the lungs.

Q. Can positive end expiratory pressure (PEEP) be used?



A. Yes, by applying an adjustable PEEP valve to the expiratory limb of the circuit.

Q. Is humidification of the inspired gas required?

A. It is preferable but not essential for short term ventilation e.g. the duration of surgery. For long term ventilation as in an intensive care unit humidification is advisable using either a filter or humidifier at the patient's airway.

3.3.2 Periodic (Monthly) Circuit integrity check

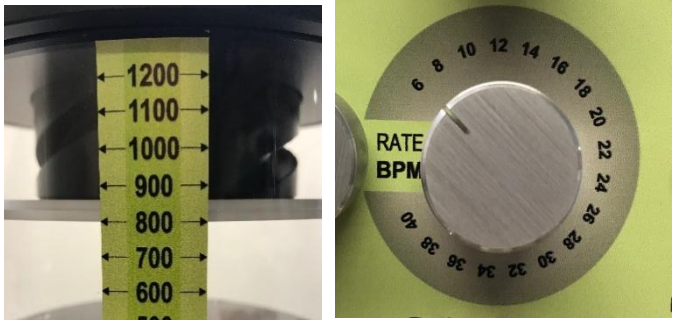
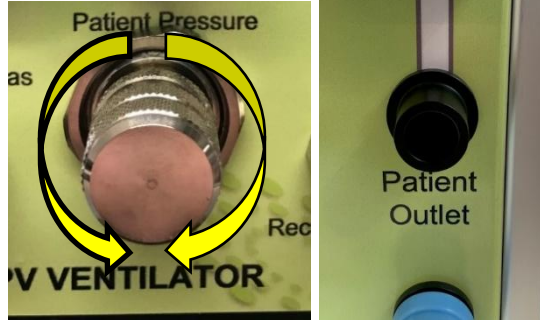
The following check should be made once a month to ensure integrity of the internal gas lines. The completion and result of this test should be recorded on the usage log (Refer to section 2.2)

<p>Set the ventilator to.</p> <ol style="list-style-type: none"> 1 800 tidal volume 2 6 BPM 	
<ol style="list-style-type: none"> 3 Wind the pressure valve in (clockwise) fully and then back (anti-clockwise) 2 turns. 4 Remove the inspiratory valve from the front control panel 	
<ol style="list-style-type: none"> 5 When the bellows have completed the up cycle, occlude the outlet completely 	
<ol style="list-style-type: none"> 6 On the down cycle check the bellows do not fall below 500 tidal volume. 	

3.4 OXYGEN ANALYSER





The Glostavent Helix Duo is fitted with an oxygen analyser.





This device measures the oxygen concentration in gas and air mixture prior to entering the vaporizer. The actual measurement takes place at the opening of the sensor which is inside the gas circuit. Due to the design of the sensor, the device should be calibrated at regular intervals (at fresh air =20.95% oxygen) to get accurate measuring values. For this reason, it is important that the following procedures are carried out to ensure that the circuit is flushed of residual O2 concentration prior to test and calibration.

If the sensor is used up, this will be detected at calibration and the sensor element must be replaced before the next measurement.

Before initial use, please read the included oxygen measuring device operating manual for configuration and setting of correct altitude setting.

<p>Start up Switch on analyser</p>		<p>Start and display test</p>  <p>If switch-off delay "P.oF" (power off) is active, this is signalled at the turn-on procedure.</p> 
<p>Test calibration Ensure concentrator is switched on. Turn oxygen flow meter to Zero. Turn air flow meter to 5l/min. Allow to run for 60 seconds. The reading on the O2 analyser should be either 20.9 or 21.0 and stable. If result is incorrect or fluctuating refer to Calibration step below.</p>		 
<p><i>In order to compensate for ageing of the sensor and air pressure fluctuations due to environment changes, the sensor should be calibrated at regular intervals or if above test procedure gives unstable or inaccurate results. The sensor will be calibrated to the atmospheric oxygen concentration of 20.95%. We recommend calibrating directly before starting the measuring process.</i></p>		

<p>Calibration Ensure concentrator is switched on. Turn oxygen flow meter to Zero</p>		<p>The calibration will be automatically completed. as soon as the measuring value is stable (takes a few seconds).</p>								
<p>Turn air flow meter to 5l/min Allow to run for 60 seconds. Press the 'cal' key and hold for 5 seconds until CAL appears on the screen</p>	 <div style="border: 1px solid black; padding: 2px; display: inline-block; text-align: center;"> CAL AIR </div>	<p>Afterwards the rating of the sensor state will be shown for a short time.</p> <div style="border: 1px solid black; padding: 2px; display: inline-block; text-align: center; margin-bottom: 10px;"> 100% </div> <p>Ensure reading is now 20.9 or 21.0 and stable indicating successful calibration.</p> <p>If calibration process is unsuccessful the following error codes may be displayed</p> <table style="width: 100%; border-collapse: collapse;"> <tr> <td style="border: 1px solid black; padding: 5px; text-align: center; width: 150px;"><i>Err.1</i></td> <td style="padding-left: 20px;">Measured value too high (Recalibrate sensor) (Change sensor)</td> </tr> <tr> <td style="border: 1px solid black; padding: 5px; text-align: center;"><i>Err.2</i></td> <td style="padding-left: 20px;">Measuring range is Undercut (Recalibrate sensor)</td> </tr> <tr> <td style="border: 1px solid black; padding: 5px; text-align: center;"><i>cAL Err.3</i></td> <td style="padding-left: 20px;">Calibration failed (Value too low) Sensor not connected or replace sensor</td> </tr> <tr> <td style="border: 1px solid black; padding: 5px; text-align: center;"><i>cAL Err.4</i></td> <td style="padding-left: 20px;">Calibration failed (Value too high) Sensor not Connected or replace sensor</td> </tr> </table>	<i>Err.1</i>	Measured value too high (Recalibrate sensor) (Change sensor)	<i>Err.2</i>	Measuring range is Undercut (Recalibrate sensor)	<i>cAL Err.3</i>	Calibration failed (Value too low) Sensor not connected or replace sensor	<i>cAL Err.4</i>	Calibration failed (Value too high) Sensor not Connected or replace sensor
<i>Err.1</i>	Measured value too high (Recalibrate sensor) (Change sensor)									
<i>Err.2</i>	Measuring range is Undercut (Recalibrate sensor)									
<i>cAL Err.3</i>	Calibration failed (Value too low) Sensor not connected or replace sensor									
<i>cAL Err.4</i>	Calibration failed (Value too high) Sensor not Connected or replace sensor									

Please refer to supplied Operating manual for additional configuration and system display codes.

Changing the oxygen sensor

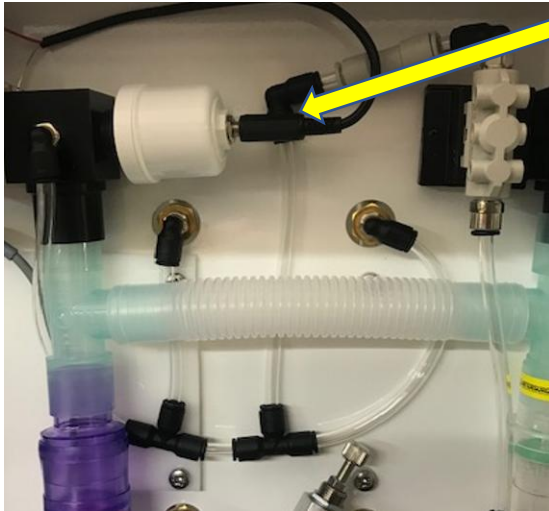

When the oxygen sensor needs replacing, firstly remove the sensor power connector.

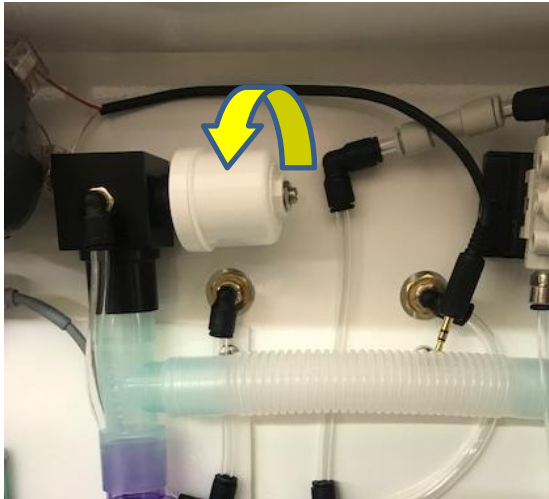
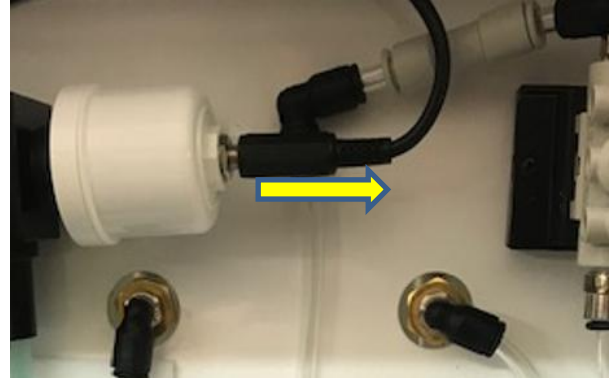

Once the sensor power connector is removed, unscrew the white sensor cell anti clockwise until fully removed.



Once the cell is removed, replace with new cell by screwing clockwise.



New cell

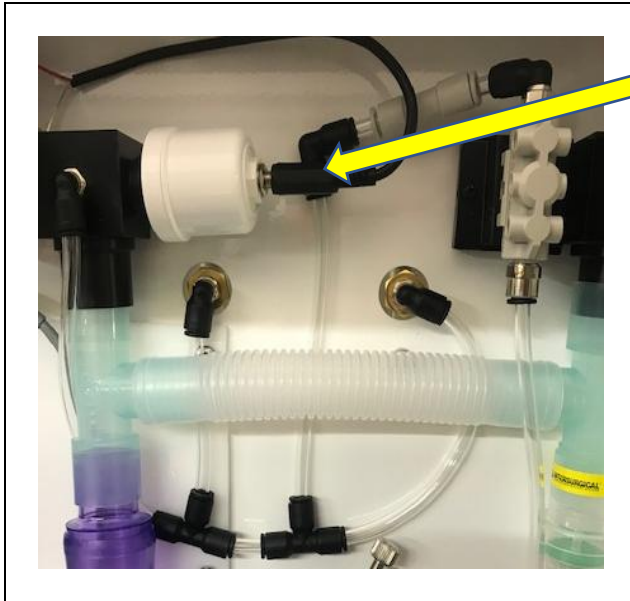

Ensure the sensor power connector is replaced and pushed on fully.

Once installation is complete refer to calibration steps above.

3.5 AVS30 AUTOMATIC VOLTAGE PROTECTION UNIT

This Glostavent anaesthesia systems are fitted with an AVS30 Voltage protection unit to automatically protect the on-board mains circuitry path from damage due to unstable voltage.

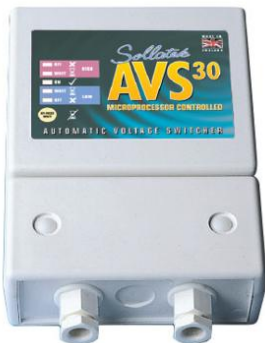

The AVS30 is an Automatic Voltage Switcher rated at 30 Amps. The AVS30 will switch off the equipment connected to it if the mains power goes outside pre-set acceptable limits, and will reconnect automatically when the mains power returns to normal. Reconnection takes place after a delay, to ensure stability of the mains.

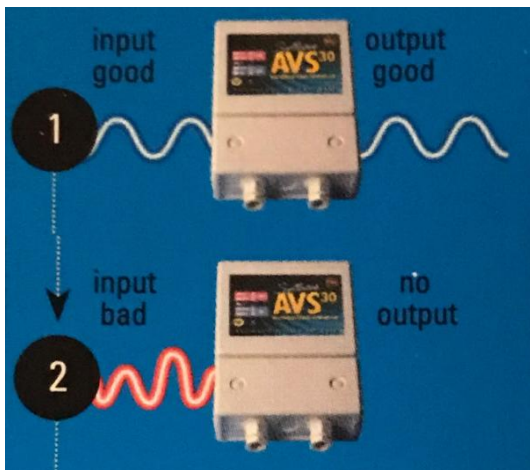

Input good
GREEN LIGHT
Power OK

Input unstable
RED LIGHT
No Power

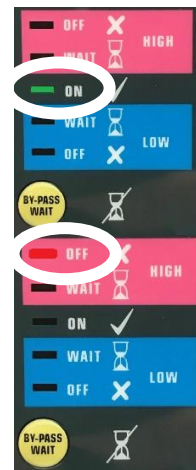

OR

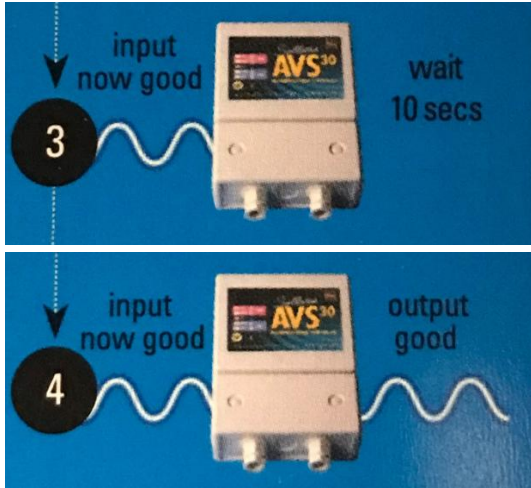

Input now good
AMBER LIGHT
 No Power for 10 seconds



OR



Input good for 10 seconds
GREEN LIGHT
 Power OK



In the event that the AVS30 unit has detected an excessive deviation from nominal power it will automatically remove supply to the UPS. This will cause the UPS to alarm for power failure and switch to battery supply mode. Once the AVS unit has monitored stable power supply within acceptable parameters for a continuous 10 seconds it will return power to the UPS which will revert to normal Line mode*. No user intervention is required throughout this process.

***NOTE** – The UPS must be set in Line mode as per section 5 of this IFU

4 THE GLOSTAVENT HELIX DUO - CONTROL AND OPERATION

Inter-Relation Of Component Parts

Below the ventilator is the oxygen concentrator ① which provides both oxygen to supplement the inspired mixture and to drive the ventilator ②. It also provides air to add gas flow for continuous flow operation if required.

An oxygen cylinder ④ should be available as a reserve, to act as a source of oxygen for the patient and to drive the ventilator in the event of failure of the concentrator. The piston requires a driving pressure of 20 PSI (140 KPa) and can therefore utilise either oxygen from the concentrator or oxygen from the cylinder. Under normal conditions, i.e., when electricity is available, the concentrator supplies both the oxygen for the patient to breathe and to drive the ventilator.

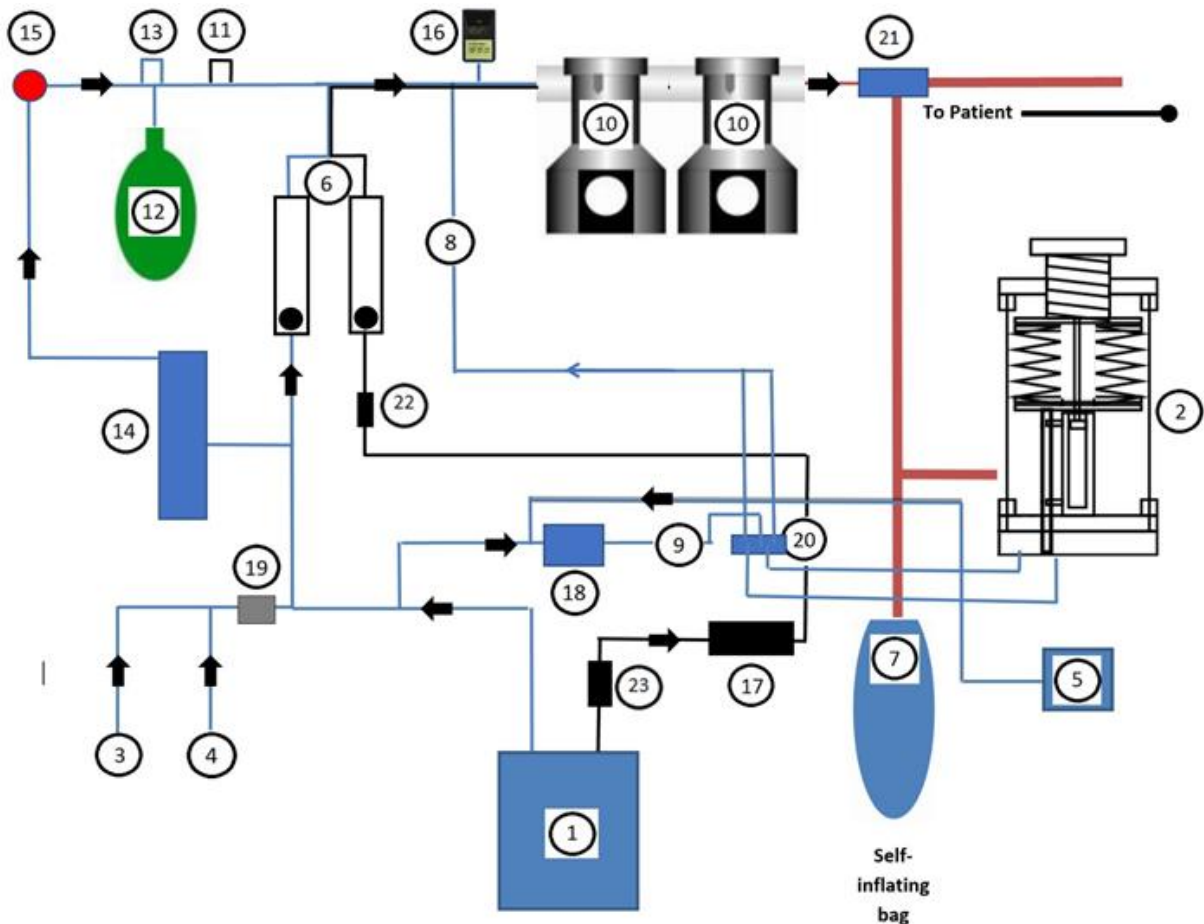

- | | |
|-----------------------------|----------------------------------|
| 1. Oxygen Concentrator | 13. Over pressure valve (5cmH20) |
| 2. Ventilator | 14. Oxygen reservoir |
| 3. Oxygen wall connection | 15. Oxygen flush |
| 4. Cylinder connection | 16. Oxygen analysers |
| 5. Back up compressor | 17. Air Reservoir |
| 6. Flowmeters | 18. Patient Pressure regulator |
| 7. Self-inflating bag | 19. Pressure regulator |
| 8. Oxygen recycled gas line | 20. Solenoid valve |
| 9. Ventilator drive gas | 21. Inspiratory Valve |
| 10. Vaporiser | 22. Air regulator |
| 11. Room air inlet | 23. Water trap |
| 12. Reservoir bag | |

If the electricity supply fails, the concentrator is no longer able to function. The reserve oxygen cylinder then takes over as the source of both the oxygen for the patient and to drive the ventilator. This change-over occurs when valve (19) opens automatically.

No intervention is required by the anaesthetist.

When the reserve oxygen cylinder is in use, conservation of oxygen assumes great importance. This is achieved in two ways;

(1) Recycling of oxygen. After the oxygen has been used to drive the ventilator it is collected and returned to the breathing circuit via the supplementary oxygen tube (8). In other words, the same oxygen is used twice, first to drive the ventilator and then to supplement the inspired gas mixture. In this way the resulting oxygen concentration delivered to the patient is elevated to 40% without the need for any other supplementation.

(2) The ventilator has been designed to minimise the volume of driving gas required. This is possible because the piston diameter is much smaller than that of the bellows. The volume of driving gas required is therefore only 1/4 of the tidal volume set for the patient. In the unlikely event of a simultaneous failure of both oxygen and electricity the anaesthetic can still continue safely using atmospheric air as the carrier gas. However, because of the respiratory depressive effects of the anaesthetic agents, controlled ventilation is required to prevent hypoxia. This can be achieved by utilising the self-inflating bag (7) supplied as part of the breathing circuit.

The Control Panel

Diagram on panel indicating gas pathway (1). Reservoir bag on left of panel (2). The function of this is to increase the volume of the reservoir and provide an indication of the rate and depth of respiration. It is not used to control or assist respiration. Bank of flow meters (3) left: oxygen from concentrator or backup (10l/min maximum) right: air from concentrator (10l/min maximum). Vaporiser (4) with concentration scale, filling port and glass window. (5) Indicates the position of the tube connecting the vaporiser to patient outlet on the panel. Note that this

tube is behind the panel and therefore not visible. It contains a one-way valve to prevent back flow of the anaesthetic gases.

A corrugated tube **6** connects the patient outlet on the panel to the ventilator. Oxygen flush button **7**. To flush the patient circuit, first switch off the vaporiser, then disconnect circuit close to the patient and depress the flush button for 10 seconds. This will flush with oxygen at a rate of 30 l per minute. Self-inflating bag **8** for manual/assisted ventilation. Helix screw **9** for tidal volume adjustment. Ventilator drive gas and return **10**. Oxygen drive gas to the ventilator **11**. Tidalvolume lock **12**.

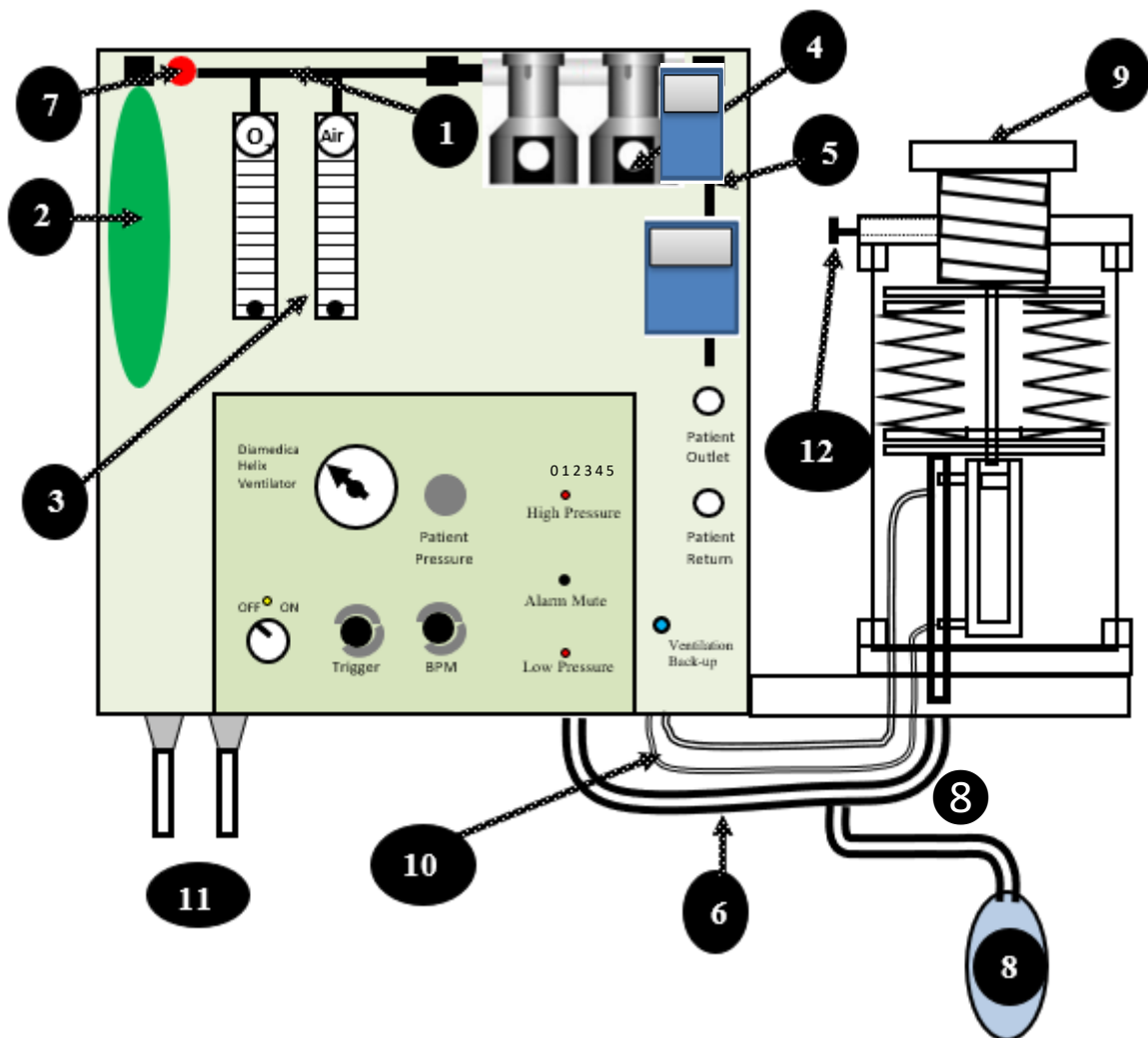

Inside View of Control Panel

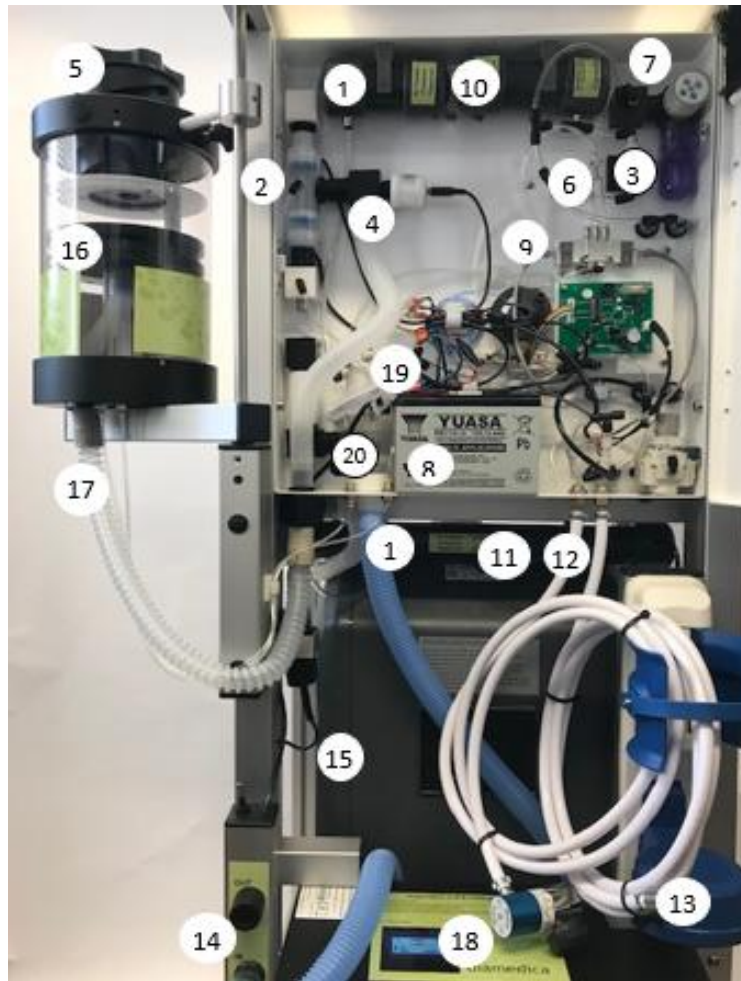

- | | |
|---|---|
| 1. Compressed air reservoirs | 11. Reserve oxygen hose |
| 2. One-way valve (after vaporiser) | 12. External oxygen hose |
| 3. 5cmH ₂ O overpressure valve | 13. Cylinder bracket |
| 4. Oxygen analyser cell | 14. Scavenger |
| 5. Ventilator tidal volume control | 15. Oxygen concentrator |
| 6. Flush valve | 16. Ventilator bellows |
| 7. One-way air inlet valve | 17. Ventilator connections |
| 8. Battery | 18. Bull nose and pin index connections |
| 9. Oxygen changeover system | 19. 2 Amp fuse |
| 10. Oxygen reservoir | 20. EXPIRATORY VALVE |

THE HELIX DUO VENTILATOR

Ventilator stored for transport.



Ventilator deployed for use.



The front panel

This contains the following features from left to right:

On /off switch with illuminated `power on` indicator above.

(top) Airway pressure gauge, (bottom) Trigger level control.

(top) Patient pressure control, (bottom) Respiratory rate control.

(top) High pressure warning light this is illuminated if the circuit pressure exceeds 50cmH₂O. (middle) Alarm Mute button. (bottom) Low pressure warning light. This is illuminated if the airway pressure fails to reach 5cm water during IPPV. After twenty seconds this is accompanied by an audible warning.

On the right-hand side are the patient outlet and return.

THE OXYGEN CONCENTRATOR



On/off switch on left of the front panel ①

White reset switch immediately above this ②, (to restore current if circuit interrupted by a surge of electricity)

Meter showing total hours of machine use ③

Oxygen tube to flowmeter and ventilator ④

Compressed air tube to air flowmeter ⑤

Low oxygen warning light ⑥. This is illuminated when the concentration of oxygen leaving the concentrator is below 85 % and is accompanied by an audible alarm. This is normal for the first few minutes after the concentrator is turned on while the oxygen concentration is gradually building up. Once the concentration reaches 70% the alarm stops automatically. If it alarms at other times it either means that the air filter needs cleaning or that the flow meter of oxygen leaving the concentrator has been set too high, i.e. beyond the capacity and must be reduced.

Power failure light ⑦

Maintenance light ⑧

REAR OF GLOSTAVENT® HELIX DUO

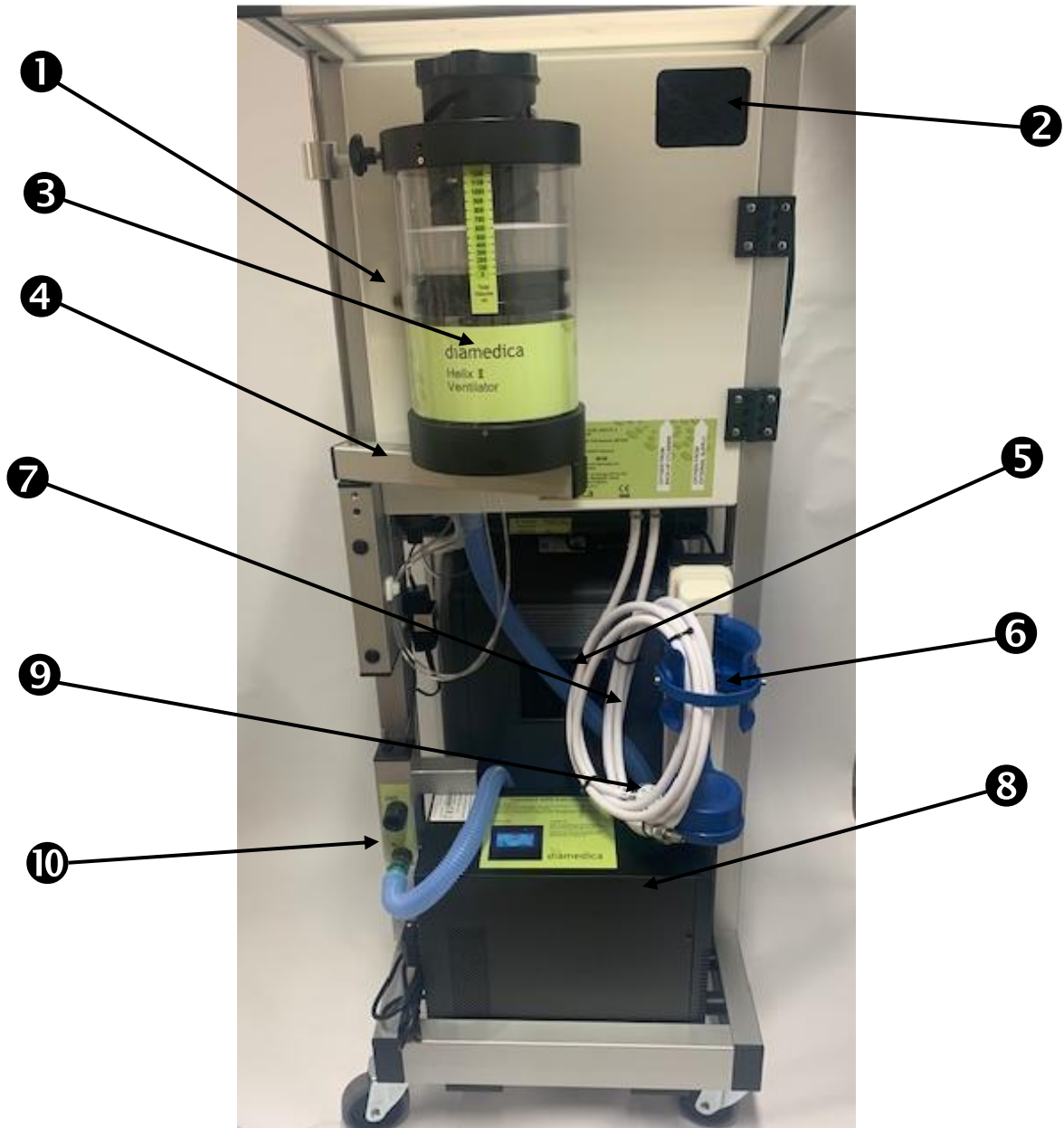

- 1 The door on the rear of the control panel and key
- 2 Filter for inspired air
- 3 ventilator
- 4 Ventilator swivel arm
- 5 Filter at rear of concentrator
- 6 Reserve oxygen cylinder holder
- 7 Auxiliary oxygen connection and hose (BS 5682)
- 8 The Uninterruptible Power Supply
- 9 Oxygen regulator (4 bar)
- 10 Scavenger unit

THE LOW-PRESSURE BREATHING CIRCUIT

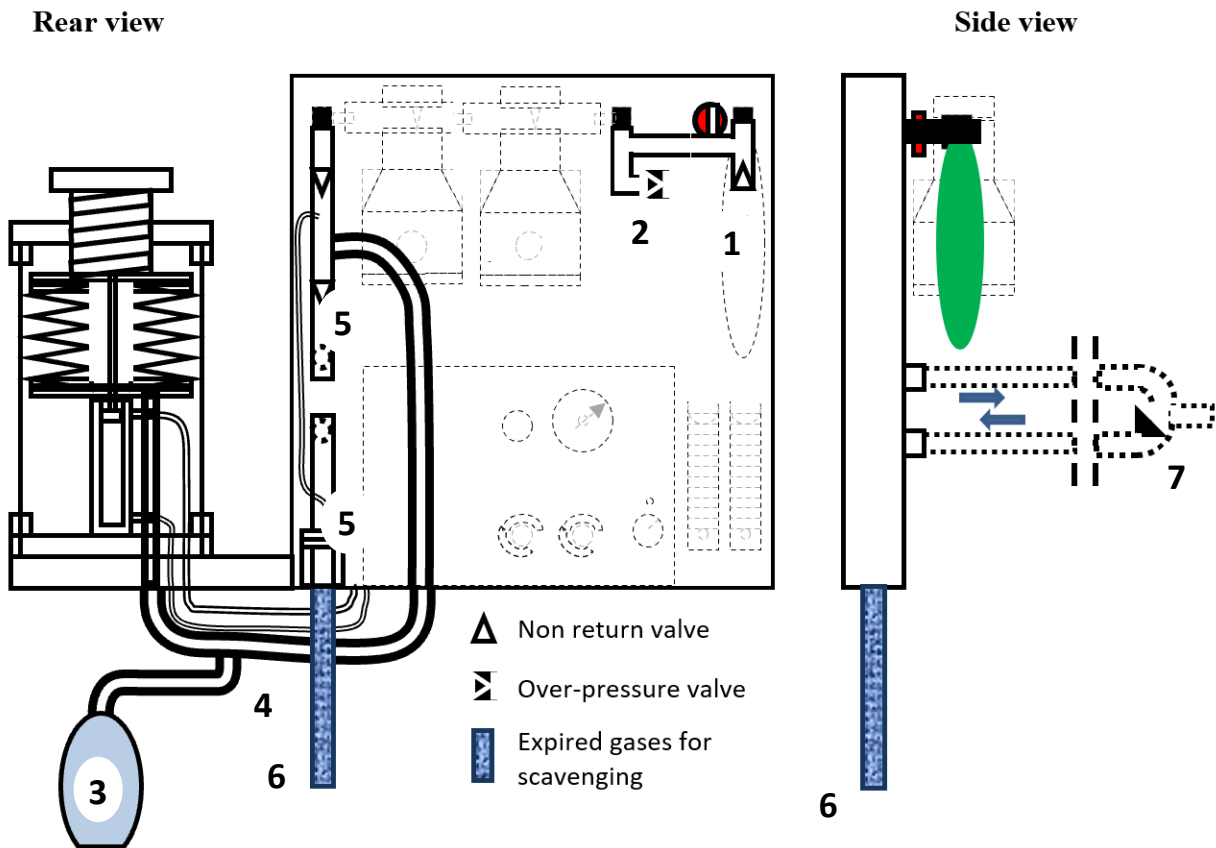

The fresh gas inlet valve ①

The over-pressure valve ②

The self-inflating bag ③ on the ventilator limb ④

The valves on the patient circuit ⑤

The expiratory limb ⑥ between the valve and the scavenging system

The patient circuit Connections for circuit are standard 22mm to fit all common circuits ⑦

Vaporiser and select system

These vaporizers are designed to be used with isoflurane (0 to 5% output) and sevoflurane (0 to 8% output)

Set both levers to zero and push down on pivot bar to select vaporiser



The Glostavent Helix Duo has two vaporisers fitted with a pivot interlock system. To select a vaporiser, first you must set both vaporisers to zero and then to select which vaporiser you require push down on the opposite pivot arm. Once selected the vaporiser lever should move freely. The opposite vaporiser will be locked in place until the selected vaporiser has been set to zero.

The vaporisers are designed to be used with specific anaesthetic agents and are equipped with filling systems to enforce the same. The filler tubes are agent specific. The fittings on the vaporiser and the collar of the bottles are specific to the agent too. This precaution is built into the design to prevent mixing of the anaesthetic agents.

Vaporisers must not be overfilled or underfilled to prevent failure of the vaporizer systems.

FILLING CAPS ARE AGENT SPECIFIC AND SHOULD NOT BE REMOVED

Note

If the pivot bar is straight you will not be able to move either vaporiser lever until one is selected.

5 THE GLOSTAVENT HELIX DUO ALTERNATIVE POWER SOURCES

Due to the likely difficult operating environments of the Glostavent® Helix Duo a number of alternative methods of driving the anaesthetic machine; both for the oxygen supply and the ventilator have been incorporated into the design. There are essentially 4 back-up systems.

5.1 UPS:

The main first line back up for electrical power failure is a UPS (Uninterruptable Power Supply) which is fitted to the rear of the machine, this will provide voltage stabilisation, surge protection, and will supply a battery back up to the oxygen concentrator of approximately 30 minutes without any interruption to the machines general running. If the UPS batteries become discharged the alarm on the concentrator will alarm continuously. Electrical connections on the UPS are IEC C13 and IEC C14 standard connections.



5.2 OXYGEN CYLINDER BACK UP

This should overcome short power interruptions that are common in many LMIC (Low- and Middle-Income Countries) while power is either restored or a generator is started. However, if those 30 minutes are not long enough an oxygen cylinder can be used to provide a source of oxygen for the patient and a means of driving the ventilator.

5.3 ADDITIONAL VENTILATION BACK UP

If the UPS batteries have discharged and there is no oxygen cylinder available then there is an emergency **Ventilation Back Up** compressor which will run the ventilator on **room air only** for approximately twelve hours. This is operated by pushing the silver button on the bottom right-hand corner of the control panel and a blue light appears when running.



When you start this, you should allow 20 seconds for the compressor to charge the system and start moving the ventilator. Once the power has been restored and the UPS has sufficient charge you must switch on the concentrator and then manually

switch the Ventilation backup off.

5.4 MANUAL VENTILATION

The final back up level if all other sources are exhausted is to manually ventilate the patient using the self-inflating bag until another source of power is available.

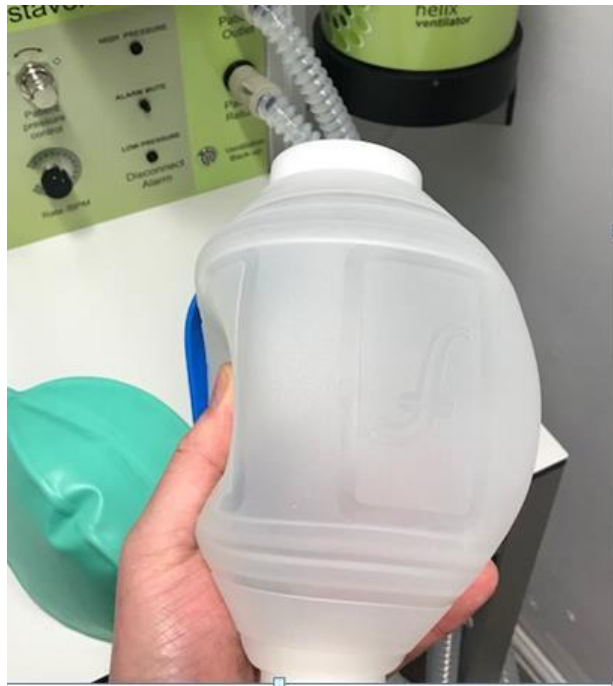

6 ASSEMBLY AND TEST PROCEDURE BEFORE USE

The system is ready to use, with only the addition of mains power connection, assembly of the patient circuit, and the addition of correct anaesthetic agent to the vaporizer.

1. First, assemble the Patient circuit to the machine
 - Connect each of the Silicone circuit limbs to the connection points on the control panel marked 'Patient Outlet' & 'Patient Return' 15mm ID tube for Paediatric patients or 22mm id tube for adult patients.
 - Connect the Y piece connector to join the trailing ends of these two tubes together.
 - The connection on the end of the Y piece will be dependent on method of patient connection required.

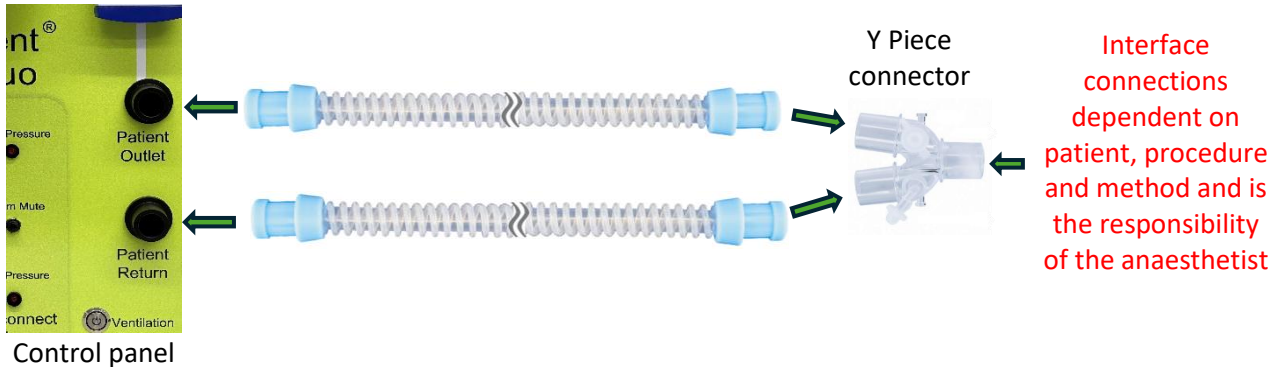

2. Confirm vaporiser contains the correct volatile agent and that concentration lever moves freely. Refill vaporiser if required.
3. Turn on oxygen cylinder if available and confirm contents on pressure gauge. Test oxygen flow meter over full range. This is located on the left of the two flow meters. Then turn off flow meter but leave cylinder on.
4. Connect 3-meter gas scavenging tube to the 30mm outlet connector, turn on gas scavenger if required.



5. Connect mains electricity to UPS and turn on electricity.
6. After connecting to the power supply, the display on the UPS will show 'Bypass' mode. Hold down the right-hand button until a signal is heard. Wait until the display shows 'Line;' mode. The UPS is now set for the Glostavent® Helix Duo to be used.



7. Turn on oxygen concentrator. Alarm sounds for five seconds then stops automatically. The oxygen monitor light, located on the right side of the front of the concentrator, is illuminated for approximately ten minutes then goes off automatically as oxygen production rises to peak efficiency. Turn on flow-meters from concentrator for air (on right) and for oxygen (on left). Turn off air flow meter.

Leave oxygen flow meter turned on and set to 2 litres/min (to prevent build-up of oxygen in concentrator).

8. Test anaesthetic circuit. Attach a one litre reservoir bag to the end of the patient circuit to act as test lung. Compress the self-inflating bag to demonstrate expansion of test lung and simultaneous movements of reservoir bag on control panel.
9. Test performance of ventilator. Set tidal volume to 600 ml (by turning the helix screw on top of the bellows), set respiratory rate to 10 breaths/min. Turn on the ventilator and confirm filling of test lung. Adjust pressure to 25 cm of water (by turning the pressure control on the front panel). Disconnect test lung. Confirm that low pressure alarm flashes within 5 seconds and audible alarm sounds approximately ten seconds later. Reconnect test lung and wait for alarm to stop.
10. Test emergency power source.
 - a. fit reserve oxygen cylinder and turn on.
 - b. turn off electricity at mains.
 - c. UPS alarm sounds (high pitched notes every 30 seconds).
 - d. turn off UPS by holding down the off button until a signal is heard.
 - e. oxygen concentrator stops working and alarm sounds.
 - f. turn off oxygen concentrator to silence alarm.
 - g. confirm ventilator continues to function (now powered by oxygen cylinder).
 - h. switch off ventilator.

After completing test procedure turn on mains and UPS, the Glostavent® Helix Duo is now ready for use

Note - After use:

1. Ensure all flow meters are turned off. Ensure UPS is connected to the mains and turned on (to keep battery charged).
2. Remove and wash filters at back of concentrator and control panel and leave to dry.
3. Inspect water trap and empty if auto drain has not emptied.
4. Cleaning and general maintenance. After use clean with a damp cloth, removing all sharps carefully. Refer to 'Daily set up and test' document for routine testing.

7 USE OF THE GLOSTAVENT[®] HELIX DUO ON ADULTS

(For use in children under 10 Kg see section 8)

1. SELECTION OF BREATHING SYSTEM

The Glostavent[®] Helix Duo is normally operated in drawover mode using the drawover breathing system described previously. This is safe, reliable, and economical and enables the anaesthetic to continue without interruption in the event of a failure in the supply of oxygen or electricity or both. It can, however, also be operated as a continuous flow machine.

2. SOURCE OF OXYGEN

Under normal circumstances, i.e. when electricity is available, it is more economical to use the concentrator rather than the reserve oxygen cylinder, both as a source of oxygen for the patient and of pressure to drive the ventilator. The oxygen cylinder, however, should always be present and turned on so that ventilation can continue without interruption if the electricity supply fails, and the oxygen concentrator is unable to function.

3. TEST PROCEDURE

Before commencing the anaesthetic, the Drawover breathing system is first attached to the common gas outlet and return of the Glostavent[®] Helix Duo and the routine pre use test procedure is carried out.

4. PRE-OXYGENATION

Pre oxygenation is best achieved using a flow of oxygen of 10 l/min or more. An airtight seal at the face mask is desirable in order to avoid dilution with room air (but is not essential) in order to create the negative pressure normally required in Drawover techniques. This is because at this high flow rate the Glostavent[®] Helix Duo automatically operates in continuous flow mode.

5. TYPE OF RESPIRATION

Conversion from spontaneous to controlled ventilation is very simple with the Drawover system. If respiration has to be assisted or controlled during the course of an anaesthetic this can be achieved by compression of the self-inflating bag rather than the reservoir bag on the control panel. This is because the latter can only generate a pressure of 5 cm water before the blow off valve opens.

If longer term ventilation is required the ventilator is turned on and the tidal volume and respiratory rate controls set as required. No other adjustment is required. The self-inflating bag on the inspiratory limb remains in place at all times.

6. VOLATILE ANAESTHETIC AGENT

At the commencement of an anaesthetic the uptake of the volatile agent is rapid after which it is gradually reduced. A dialled concentration of approximately 2 MAC for the first 15 minutes followed by 1.5 MAC thereafter is generally satisfactory.

MAC stands for minimal anaesthetic concentration required to produce surgical anaesthesia and is specific to each anaesthetic agent. e.g., the value of 1 MAC for halothane is 0.75% and for isoflurane 1.1%. Thus, in the above example, if Halothane is being used the dialled concentration would be 1.5% for 15 minutes and 1.0% thereafter, adjusting this according to the patient's response.

7. AGENT MONITORING

In situations in which the electricity supply is unreliable or when there is no technical support capable of maintaining delicate monitoring devices in good working order the use of monitors, normally considered indispensable for the conduct of safe anaesthesia, may be impossible.

Their presence is however not essential during Drawover anaesthesia since the concentration of the agent being inhaled is the same as the concentration setting on the vaporiser. It is delivered directly to the patient and not diluted by the lower concentration in expired gases as occurs with a circle system using low fresh gas flows.

8. ANALGESIA

The analgesic component of the anaesthetic can be achieved satisfactorily using intravenous analgesics incrementally according to the patient's response. In patients breathing spontaneously the respiratory rate is a useful guide to the requirements and the rate of administration can be adjusted to achieve a respiratory rate between 10 and 20 breaths per minute (in small children a rate of 20-30 breaths per minute is satisfactory). The alternative is to use local or regional anaesthesia as the analgesic component. This has the advantage that analgesia continues beyond the end of the anaesthesia.

9. MONITORING RESPIRATION

If gas analysis and oximetry are not available monitoring of respiration depends on good clinical observation of the patient and breathing system.

In spontaneously breathing patient's movement of the reservoir bag on the control panel gives an indication of the depth and rate of respiration. The patient's colour and movement of the chest and diaphragm must be kept under close observation throughout the administration of the anaesthetic. Provided the rate and depth of respiration is satisfactory, rebreathing and hypercarbia should not occur with the Drawover system as the expired gases are completely ducted away from the circuit by the valve at the patient airway.

Always check the patient – a rise in inflation pressure may also indicate bronchospasm, anaphylaxis, fluid overload, bronchial intubation. Seek and treat the cause first, do not immediately turn the ventilation up.

10. INSPIRED OXYGEN CONCENTRATION

When using the Drawover system there is no danger of delivering a hypoxic mixture since oxygen is ADDED to room air (containing 21% oxygen) so the resulting concentration of oxygen will go up rather than down.

The inspired oxygen concentration depends on the ratio of the flow rate of added oxygen to the patient's respiratory minute volume.

In practice, a flow rate of oxygen of 2 litres/minute in a patient breathing 5 litres/min will give an oxygen concentration of approximately 50 %. If higher concentrations are required the flow rate is increased accordingly.

IMPORTANT NOTE: In the unlikely event of a simultaneous failure of both oxygen and electricity the anaesthetic can still continue safely using atmospheric air as the carrier gas. In these circumstances, it is advisable to assist or control respiration to counter the respiratory depressive effects of the anaesthetic agents.

11. AFTER USE.

At the conclusion of the operating session:

1. Turn off the concentrator.
2. Turn off the oxygen cylinder.
3. Ensure that the mains electricity supply is connected, and the UPS is turned on so that the battery is kept fully charged.
4. Remove the patient circuit, wash in soapy water, rinse, and leave to dry.

12. LONG TERM VENTILATION

Although the Glostavent[®] Helix Duo was designed as an anaesthetic machine it can also function as a ventilator in a recovery room or intensive care unit. No adaptation is required for long term ventilation. The tidal volume and respiratory rate are set to the desired levels and the vaporiser is turned off.

Room air is supplemented with oxygen from the concentrator to give the required inspired oxygen concentration.

To assist with weaning a patient from long term respiratory support a triggering mechanism can be activated by a manual control located on the front of the control panel. This indicates the inspiratory effort required to initiate compression of the bellows and is gradually increased as the patient regains muscle power.

Positive end expiratory pressure (PEEP) is occasionally required in some forms of lung dysfunction and this can be applied by attaching a PEEP valve to the expiratory limb of the breathing system.

8 USE IN PAEDIATRIC PATIENTS

Children weighing 10 Kg and above are able to use the Glostavent® Helix Duo as described above for adults.

Small children breathing spontaneously may have difficulty in generating enough inspiratory flow to produce the necessary pressure gradient across the vaporiser, which therefore fails to deliver enough anaesthetic. For this reason, many anaesthetists may prefer to use the continuous flow mode for children weighing less than 20 kg.

When using the Glostavent® Helix Duo in these children the standard breathing circuit is first removed from the common gas outlet of the Glostavent® Helix Duo and replaced by a 'T' piece paediatric system (Mapleson F). The reservoir bag is used to indicate respiratory movements during spontaneous respiration and, with the expiratory port partially occluded, to facilitate controlled ventilation. This paediatric 'T' piece system is used with the recommended fresh gas flows i.e. 3 times the patient's estimated respiratory minute volume down to a minimum of 3 l/min.

To enable the 'T' piece circuit to be used in this way the pressure at the common gas outlet must be positive. This occurs automatically when the dialled gas flows exceed the patient's minute volume and normally requires no additional action by the anaesthetist.

N.B The open end of the 'T' piece reservoir BAG must NOT be completely occluded as this is the port for expired gases.

Both spontaneous and controlled respiration can be used with this arrangement as if using a standard continuous flow anaesthetic machine. However, it should be noted that the maximum pressure that can be applied during controlled ventilation is limited to the pressure set by the control on the ventilator panel.

9 PEEP (POSITIVE END EXPIRATORY PRESSURE)

PEEP can be fitted to the Glostavent Helix Duo by connecting it to the patient return ensuring the correct direction of flow.



To adjust the PEEP valve

The PEEP valve can be removed by pulling the valve from the clear case. To adjust the valve, turn red cap clockwise to increase pressure and anti-clockwise to reduce pressure. The PEEP valve pressure ranges from 0-20 cmH₂O.



10 ALARMS

The Glostavent Helix Duo has the following alarm modes.

	Alarm Priority*	Audible (Constant or intermittent)	Sound level (db)**	LED Colour	Constant or Flashing	Comments
Low pressure / disconnect	Medium	Audible following 20 seconds maximum (See comments)	>45db	Red	Intermittent for 15 seconds Constant after 15 seconds	The Low pressure disconnect alarm has a 5 second delay this is to avoid activation between breath cycles.
High pressure	Medium	Constant	>45db	Red	Constant	
Battery level low	Low	None	N/A	Green	Flashing	LED flashes when level @ < 2 hours running time
Battery failure	Medium	Constant	>45db	None	None	Activated when battery capacity is no longer sufficient to run the solenoids. Bellows ceases to operate. Nominal 15 minutes activation.

*Manual ventilation option built into patient circuit for immediate use.

**Audible alarm may be silenced by the mute button for 15 seconds. Visual warning remains on.

Unit should be positioned adjacent to the patient such that the operators eyeline is within a 120° sweep angle to the front of the Glostavent Helix Duo to ensure clear vision of the warning lights.

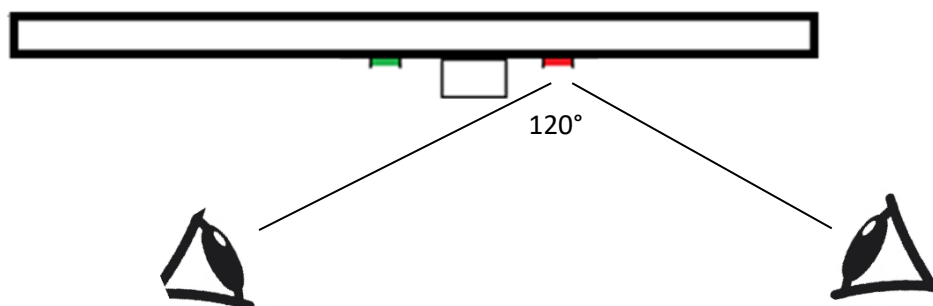

10.1 Testing alarms

With unit connected to a suitable drive gas source and patient circuit connected switch on the unit. Set the rate to 10 – 12 BPM and adjust the tidal volume to approximately 600. Ensure the ventilator is running correctly.

Low pressure disconnect.

Disconnect the patient inspiratory tube (Patient outlet) from the control panel. The low-pressure warning light should illuminate after 5 seconds. After a further 20 seconds maximum the constant audible alarm should start.

Press the mute alarm button at which point the audible alarm should silence, the warning light will remain on. After a further 15 seconds the audible alarm should restart.

Reconnect patient circuit block and ensure that alarm goes off (audible and warning light). This may take a few seconds.



High pressure

Slide both weights to the maximum pressure setting on the ventilator. Occlude the patient connection on the patient valve and observe the pressure gauge on the front panel. Observing the pressure gauge whilst completing this to ensure that it reaches its maximum. Ensure that on reaching 60cmH₂O that the high- pressure alarm LED illuminates and the alarm sounds.



Battery level low (Flashing green light indicates < 2 hours operation left)

Not tested. Low level battery warnings should be recorded on usage log comments (Refer to Section 3) Battery life > 300 hours, if indications of low battery levels occur at lesser intervals than this, a new battery should be considered. This is available by contacting Diamedica – support@diamedica.co.uk

Battery failure

Not tested.

11 ELECTROMAGNETIC COMPATIBILITY

The Glostavent Helix Duo Anaesthesia machine is a mains powered mobile medical device that has been assessed and complies against the applicable requirements of EN 60601-1-2:2015.

Guidance and manufacturer's declaration – electromagnetic emissions			
The GLOSTAVENT HELIX DUO is intended for use in the electromagnetic environment specified below. The customer or the user of the GLOSTAVENT HELIX DUO should assure that it is used in such an environment.			
Emission test	Compliance	Electromagnetic environment - guidance	
RF emissions CISPR 11	Class B	The GLOSTAVENT HELIX DUO uses RF energy only for its internal function. Therefore, its RF emissions are very low and are not likely to cause any interference in nearby electronic equipment.	
RF emissions CISPR 11	Class B	The GLOSTAVENT HELIX DUO is suitable for use in all establishments, including domestic establishments and those directly connected to the public low-voltage power supply network that supplies buildings used for domestic purposes.	
Harmonic emissions IEC61000-3-2	Class A		
Voltage fluctuations / flicker emissions IEC61000-3-3	Complies		
Immunity test	IEC 60601 test level	Compliance level	Electromagnetic environment - guidance
Electrostatic discharge (ESD) IEC61000-4-2	± 8 kV contact ± 15 kV air	± 8 kV contact ± 15 kV air	Floors should be wood, concrete or ceramic tile. If floors are covered with synthetic material,
Electrical fast transient / burst IEC61000-4-4	± 2 kV for power supply lines ± 1 kV for input / output lines	± 2 kV for power supply lines ± 1 kV for input / output lines	Mains power quality should be that of a typical commercial or hospital
Surge IEC61000-4-5	± 1 kV line(s) to line(s) ± 2 kV line(s) to earth	± 1 kV line(s) to line(s) ± 2 kV line(s) to earth	Mains power quality should be that of a typical commercial or hospital
Voltage dips, short interruptions and voltage variations on power supply input lines IEC61000-4-11	<5% U_T (>95 % dip in U_T) For 0.5 cycle 40% U_T (60 % dip in U_T) for 5 cycles 70 % U_T (30 % dip in U_T)	<5% U_T (>95 % dip in U_T) For 0.5 cycle 40% U_T (60 % dip in U_T) for 5 cycles 70 % U_T (30 % dip in U_T)	Mains power quality should be that of a typical commercial or hospital environment. If the user of the GLOSTAVENT HELIX DUO requires continued operation during power mains interruptions, it is

	for 25 cycles <5% U_T (>95 % dip in U_T) For 5 s	for 25 cycles <5% U_T (>95 % dip in U_T) For 5 s	recommended that the GLOSTAVENT HELIX DUO be powered from an uninterruptable power supply or a battery.
Power frequency (50/60Hz) Magnetic field IEC61000-4-8	30 A/m	30 A/m	Power frequency magnetic fields should be at levels characteristics of a typical location in a
Conducted RF IEC61000-4-6	3 Vrms 150 kHz to 80 MHz 6Vrms in ISM bands between 0.15- 80MHz	3Vrms 6Vrms	Portable and mobile RF communications equipment should be used no closer to any part of the GLOSTAVENT HELIX DUO, including any cables, than the recommended separation distance calculated from the equation applicable to the frequency of the transmitter. Recommended separation distance (d) $d = 1.2\sqrt{P}$ $d = 1.2\sqrt{P}$ 80 MHz to 800 MHz $d = 2.3\sqrt{P}$ 800 MHz to 2.5 GHz
Radiated RF IEC61000-4-3	3 V/m 80 MHz to 2.5 GHz	3V/m	Where P is the maximum output power rating of the transmitter in watts (W) according to the transmitter manufacturer and d is the recommended separation distance in metres (m). Fields strengths from fixed RF transmitters, as determined by an electromagnetic site survey, ^a should be less than the compliance level in each frequency range. ^b Interference may occur in the vicinity of equipment marked with the following symbol: 

Proximity fields from RF wireless communications IEC61000-4-3	Frequency - Test Level	Frequency - Test Level	<small>Fields strengths from fixed RF transmitters, as determined by an electromagnetic site survey,^a should be less than the compliance level in each frequency range.^b</small> <small>Interference may occur in the vicinity of equipment marked with the following symbol:</small> 
	385MHz - 27 V/m	385MHz - 27 V/m	
	450MHz - 28 V/m	450MHz - 28 V/m	
	710MHz - 9V/m	710MHz - 9V/m	
	745MHz - 9V/m	745MHz - 9V/m	
	780MHz - 9V/m	780MHz - 9V/m	
	780MHz - 9V/m	810MHz - 28 V/m	
	810MHz - 28 V/m	870MHz - 28 V/m	
	870MHz - 28 V/m	930MHz - 28 V/m	
	930MHz - 28 V/m	1.72GHz - 28 V/m	
	1.72GHz - 28 V/m	1.845GHz - 28 V/m	
	1.845GHz - 28 V/m	1.97GHz - 28 V/m	
	1.97GHz - 28 V/m	2.45 GHz - 28 V/m	
	2.45 GHz - 28 V/m	5.24GHz - 9V/m	
	5.24GHz - 9V/m	5.50GHz - 9V/m	
5.50GHz - 9V/m	5.875GHz - 9V/m		
5.875GHz - 9V/m			

NOTE U_T is the a.c. mains voltage prior to application of the test level.

NOTE 1 At 80 MHz and 800 MHz, the higher frequency range applies.

NOTE 2 These guidelines may not apply in all situations. Electromagnetic propagation is affected by absorption and reflection from structures, objects and people.

^a Field strengths from fixed transmitters, such as base stations for radio (cellular/cordless) telephones and land mobile radios, amateur radio, AM and FM radio broadcast and TV broadcast cannot be predicted theoretically with accuracy. To assess the electromagnetic environment due to fixed RF transmitters, an electromagnetic site survey should be considered. If the measured field strength in the location in which the NR6 is used exceeds the applicable RF compliance level above, the GLOSTAVENT HELIX DUO should be observed to verify normal operation. If abnormal performance is observed, additional measures may be necessary, such as re-orientating or relocating the GLOSTAVENT HELIX DUO

^b Over the frequency range 150 kHz to 80 MHz, field strengths should be less than 3V/m.

Refer to the Oxygen Concentrator manual for specifications on Electromagnetic compatibility.

Whilst every precaution has been taken to prevent the effect on or effect from other devices the following precautions should be adhered to ensure continued normal operation.

Always ensure that the device is used in accordance with the Instructions for Use.

Use of this equipment adjacent to or stacked with other equipment should be avoided. If such use cannot be avoided, both items should be observed to verify that they are operating normally.

Only use the power leads supplied.

The implementation of accessories or spares, other than those specified, provided, or advised by the manufacturer of this equipment should not be used. Failure to follow this could result in increased electromagnetic emissions or decreased electromagnetic immunity of this equipment and result in improper operation.

If this equipment is found to cause interference or be affected by interference from other devices, which can be determined by turning the equipment off and on, the user is encouraged to try to correct the interference by one or more of the following measures:

Reorient or relocate either device to increase the separation between the equipment. If the unit is charged disconnect from the power supply and remove power lead.

Consult the manufacturer for help when required.

12 TROUBLE SHOOTING

Situations requiring the immediate attention of the anaesthetist.

N.B. in the event of any other malfunction the Glostavent[®] Helix Duo must be taken out of service immediately and advice sought from Diamedica. Under no circumstances should there be any unauthorised tampering with the inside of the Glostavent[®] Helix Duo by untrained personnel.

1. The alarm on the UPS sounds

Cause: The electricity supply to the UPS has been interrupted.

Response: Turn off the UPS to silence the alarm, ensure that the electrical connections from the mains are intact. If the supply is off at the mains, then the UPS will continue to supply electricity for the next twenty minutes after which the oxygen concentrator will stop working (see 2 below). *The principal function of the UPS is to remove voltage fluctuations from the electrical power supplies.*

2. Continuous alarm from the oxygen concentrator

Cause: the electricity supply has been interrupted and the UPS batteries have depleted either due to a failure of the mains supply or activation of the safety cut off mechanism caused by a surge in the voltage. Alternatively, the oxygen flow meter has been set too high i.e. beyond the maximum capacity of 10 litres/min.

Response: Turn off the concentrator to silence the alarm. Check electrical connections. If mains electricity failure is confirmed the oxygen cylinder automatically takes over the supply of oxygen to the patient and driving gas to the ventilator. Supplementary oxygen from the cylinder can be added via the flow meter if required. If the reset button has been activated it should be depressed to restore function. If the oxygen output at the flow meter has been set too high (i.e. beyond the capacity of the concentrator of 10 l/min) the flow meter is re-set at a lower level and the concentrator restarted.

3. Intermittent alarm from the oxygen concentrator.

Cause: The oxygen flow meter is turned off leading to a build-up of oxygen pressure in the concentrator.

Response: Turn off concentrator to silence alarm. Turn on flow meter to say 2 l/min to enable oxygen to leave the concentrator. Turn on concentrator.

4. Low oxygen warning light on concentrator becomes illuminated.

Cause: This is normal for the first ten to fifteen minutes of use as the concentrator is warming up and approaching maximum efficiency. No action is required at this stage. If the warning remains illuminated after this time it means the filter may be obstructed.

Response: The filter is changed or washed.

5. Low pressure alarm sounds on ventilator and warning light illuminated.

Cause: There is a leak or complete disconnection of the anaesthetic tubing. Alternatively, the tidal volume setting is too low for the size of patient.

Response: Depress the mute button to silence the alarm. Look for obvious source of leaks and or disconnections and restore integrity. If no leak is immediately evident turn off ventilator and commence manual ventilation with self-inflating bag. Look carefully for source of leaks and or disconnections and restore integrity. Re-start ventilator. If low pressure alarm continues to sound, increase tidal volume setting until sufficient pressure is generated.

6. Failure of bellows to fill completely.

Cause: Loss of drive gas pressure.

Response: Continue ventilation manually until a further source of drive gas is available.

7. Failure of bellows to empty completely.

Cause: There may be an increased resistance to breathing due to an obstruction to the anaesthetic tubing (e.g. kinking) or an obstruction to the patient's airway (e.g. bronchospasm, secretions).

Response: Change to manual ventilation, seek and relieve any cause of obstruction. If the bellows still do not empty completely increase the patient pressure control.

8. Sudden failure of bellows. No movement possible in either direction.

Cause: There is a mechanical fault inside the ventilator.

Response: Turn the ventilator off and continue with manual ventilation via the self-inflating bag. Consult the manufacturers for advice. **DO NOT TAMPER WITH THE INSIDE OF THE VENTILATOR.**

9. Failure to generate pressure during manual compression of self-inflating bag.

Cause: The bellows in the ventilator may need to be closed, turn the helix screw on the ventilator clockwise until the bellows is closed. There may be a disconnection between the bag and the common gas outlet of the Glostavent® Helix allowing the contents of the bag to be discharged into the atmosphere rather than into the patient.

Response: Re-connect the tubing and continue to compress the bag.

10. There is a low-pitched rumbling noise from the valve system on expiration.

Cause: The total flow rate dialled exceeds the patient's minute volume, causing distension of the reservoir bag and a build-up of pressure. This leads to fluttering of the valve flap which is audible during expiration.

Response: The flow rates are reduced till they are below the patient's minute volume. When this occurs, the rumbling noise disappears, and the reservoir bag moves with respiration.

11. The patient unexpectedly shows signs of light anaesthesia.

Cause: The patient may not be receiving the anaesthetic.

Response: Check that the vaporiser contains the anaesthetic agent and that it is turned on to the desired concentration. Confirm that the reservoir bag moves in time with respiration. Failure of the reservoir bag to move in time with respiration indicates a disconnection on the patient side of the vaporiser so that the patient is receiving atmospheric air instead of the anaesthetic! Check all connections to ensure the circuit is intact.









12. The supply of both oxygen and electricity fail simultaneously.

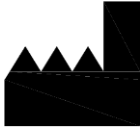







Cause: Whatever the cause the response must be immediate as there is no supplementary oxygen for the patients to breathe and no driving gas for the ventilator.





Response: The anaesthetic is maintained using atmospheric air as the carrier gas. Because of the depressant effect on respiration of the anaesthetic agents-controlled ventilation via the self-inflating bag is advised.

13 SYMBOLS GLOSSARY

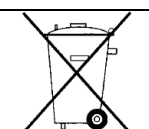
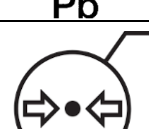
Some or all the following symbols may be used within this manual or found on the product or packaging labels. Please familiarize yourself with them:

Symbol	Description	Comment
	Manufacturer	Indicates the medical device manufacturer
	Authorized representative in the European Community	Indicates the Authorized representative in the European Community.
	Date of manufacture	Indicates the date when the medical device was manufactured.
	Use-by date	Indicates the date after which the medical device is not to be used.
	Batch code	This symbol shall be accompanied by the manufacturer's batch code. The batch code shall be adjacent to the symbol.
	Catalogue number	Indicates the manufacturer's catalogue number so that the medical device can be identified.
	Serial number	Indicates the manufacturer's serial number so that a specific medical device can be identified.
	Fragile, handle with care	Indicates a medical device that can be broken or damaged if not handled carefully.
	Keep dry	Indicates a medical device that needs to be protected from moisture.

	Refer to the Instruction Manual	Indicates the user <u>must</u> read the instructions for use before using the equipment.
	Caution	Indicates the need for the user to consult the instructions for use for important cautionary information such as warnings and precautions that cannot, for a variety of reasons, be presented on the medical device itself.
	Warning	Risk to people specified by the supplementary sign Taking care regarding the hazard specified by the supplementary sign
	Crush hazard	
	Do not push	
	Class I equipment	
	Type B applied part	
	Recycling symbol	Products with this symbol should not be disposed of in the bin
	The battery recycling symbol	Chemical symbol for battery type included beneath
	Atmospheric pressure limitation	Indicates the range of atmospheric pressure to which the medical device can be safely exposed.

	Humidity limitation	Indicates the range of humidity to which the medical device can be safely exposed.
	Temperature limit	Indicates the temperature limits to which the medical device can be safely exposed
	Medical device	Indicates the item is a medical device
	Unique Device Identifier	Indicates a carrier that contains Unique Device Identifier information